

EPOS

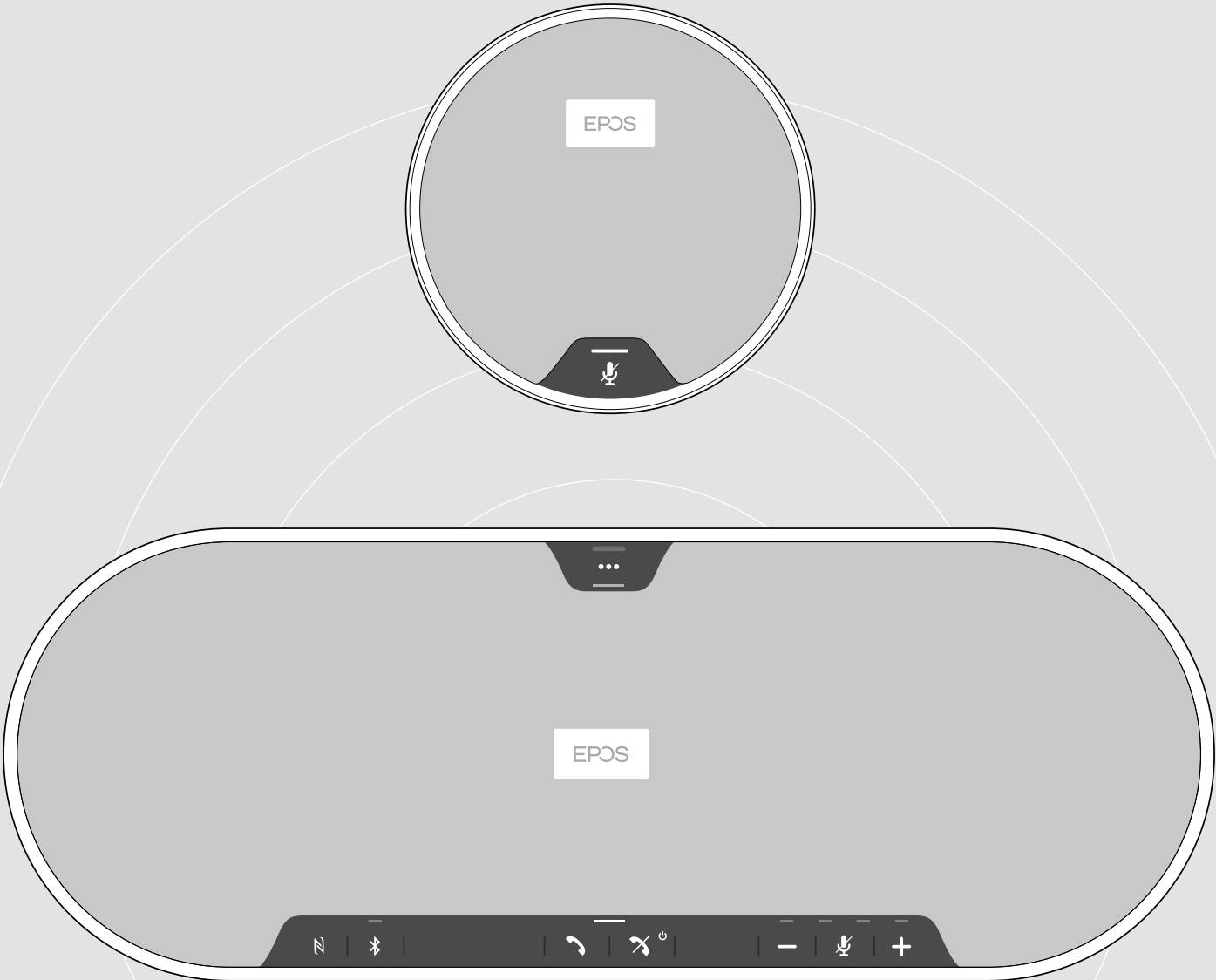

EXPAND 80 | EXPAND 80 Mic

Bluetooth® Speakerphone | Expansion microphone

User Guide

Contents

The EXPAND 80 speakerphone EXPAND 80 Mic expansion microphone.....	2
Package contents and further information.....	3
Package contents EXPAND 80 speakerphone.....	3
Package contents EXPAND 80 Mic.....	4
Safety instructions, software and accessories.....	4
Product overview.....	5
Overview of the speakerphone.....	5
Overview of the dongle.....	7
Overview of expansion microphone.....	8
Overview of the icons.....	8
Getting started.....	9
Positioning the speakerphone and the expansion microphone(s).....	9
Connecting the expansion microphone(s).....	10
Connecting the speakerphone to the mains power supply.....	11
Connection possibilities.....	12
A: Connecting via USB cable.....	12
B C D About pairing and using with wireless Bluetooth® devices.....	13
B: Pairing the speakerphone and a mobile device via NFC™.....	14
C: Pairing the speakerphone and a mobile device via Bluetooth®.....	15
D: Connecting the Bluetooth® dongle to a computer and pairing the speakerphone.....	16
Installing EPOS software.....	17
Changing Audio settings for the speakerphone – Microsoft® Windows.....	17
Using the speakerphone.....	18
Turning the speakerphone and the expansion microphone(s) on.....	18
Connecting / disconnecting Bluetooth® devices.....	18
Turning the speakerphone and the expansion microphone(s) off.....	19
Adjusting the volume.....	20
Muting the microphone(s).....	20
Making calls using the speakerphone.....	21
Making a call.....	21
Accepting/rejecting/ending a call.....	21
Redialing.....	22
Using the voice assistant.....	22
Managing multiple calls.....	23
Merging calls – Conference.....	25
Listening to music using the speakerphone – media playback.....	26
Good to know.....	27
Switching between Bluetooth® personal and shared mode.....	27
Waking up from standby.....	27
Enabling / disabling voice prompts.....	28
Using an optional Kensington® lock.....	28
Bluetooth® transmission range.....	29
Storing the dongle and the expansion microphone.....	29
Maintaining and updating the products.....	30
Cleaning the products.....	30
Updating the firmware of the products.....	31
If a problem occurs.....	33
Frequently asked questions.....	33
Clearing pairing list.....	34
Restoring default settings.....	35
Specifications.....	36

The EXPAND 80 speakerphone | EXPAND 80 Mic expansion microphone

The EXPAND 80 speakerphone

Unite colleagues with a premium, scalable Bluetooth® speakerphone for up to 16 in-room participants.

Thanks to six adaptive, beamforming microphones that isolate the human voice from room reverb and ambient noise, everyone in the room can be heard and colleagues out of the office are closer to the conversation.

Connect easily via Bluetooth, USB-C or NFC and listen as the room fills up with rich, natural sound – perfect for dynamic conferences and audio-visual presentations.

Crafted with high-quality materials and fabric by Kvadrat, you get enhanced sound and a professional aesthetic of your workplace.

For even larger meetings, expansion microphones allow you to adapt to the demands of your business.

EXPAND 80 offers a space to meet and align in real time – enabling the confidence and clarity that boosts collective performance.

The EXPAND 80 Mic

Boost the range of your EXPAND 80 speakerphone with expansion microphones that enable superb call clarity optimized for UC and certified for Microsoft Teams.

Attach one or two microphones to fit the size of your meeting room and optimize your collaborations.

Ensure effective communication where all participants are close to noise-cancelling microphones that deliver excellent voice clarity.

Maintain a professional, stylish conference table with smart cable management developed for optimal system function and ease of use.

Crafted from the same high-quality materials as EXPAND 80, EXPAND 80 Mic creates a unified look and feel to your meeting room and elevates the interior design.

Extend the range and possibilities of your EXPAND 80 conference solution and empower the performance of your entire team.

Key benefits & features

Get your message through with EPOS Voice™
Six adaptive, beamforming microphones and DSP intelligently isolate voices from room reverb and ambient noise

Rich, natural sound
Powerful ultra-low distortion speaker in a unique patent pending suspended speaker box fills the room with outstanding sound

Superior craftsmanship, statement Scandinavian design
Crafted with high-quality materials and sound-enhancing fabric by Kvadrat with a premium, minimalist aesthetic

Expand your meetings
Attach up to two expansion microphones for larger meetings

Set up your conference call in seconds
Enjoy multiple connectivity options, an intuitive user interface and one touch access to your preferred Voice Assistant or Microsoft Teams

Key benefits & features

Larger meetings UC optimized, and Microsoft Teams certified
For larger meetings attach up to two expansion microphones for a UC optimized and Microsoft Teams certified experience

Ensure everyone is heard clearly
Each EXPAND 80 Mic contains 4 beamforming microphones, so every in-room participant is always close to a microphone





Smart cable management for professional, stylish meetings
Customize cable length to your meeting room with smart cable management for an optimal system setup

Plug and play conferencing
Simply plug into the EXPAND 80 and start your meeting. Once connected the entire set-up acts as one integrated system

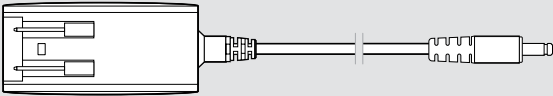

Statement Scandinavian design
With sleek, minimal aesthetic and high-quality materials that match EXPAND 80

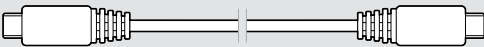
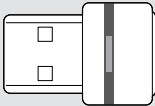
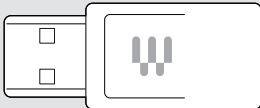
Package contents and further information

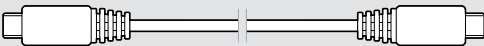

Package contents EXPAND 80 speakerphone

	<p>EXPAND 80 Bluetooth speakerphone</p>
	<p>Power supply unit</p>
	<p>Country adapters EU, AU, UK</p>
	<p>USB-C® cable</p>
	<p>BTD 800 USB Bluetooth® dongle</p>
	<p>USB-C® to USB-A adapter</p>
	<p>Quick Guide Safety Guide Compliance sheet</p>

Package contents EXPAND 80 Mic

	EXPAND 80 Mic Expansion microphone
	USB-C® cable
	Quick Guide Safety Guide Compliance sheet

Safety instructions, software and accessories

	For safety instructions, consult the Safety Guide.
	The free EPOS software EPOS Connect allows you to add value to your EPOS products.
	A list of accessories can be found on the product page at www.eposaudio.com .

Product overview



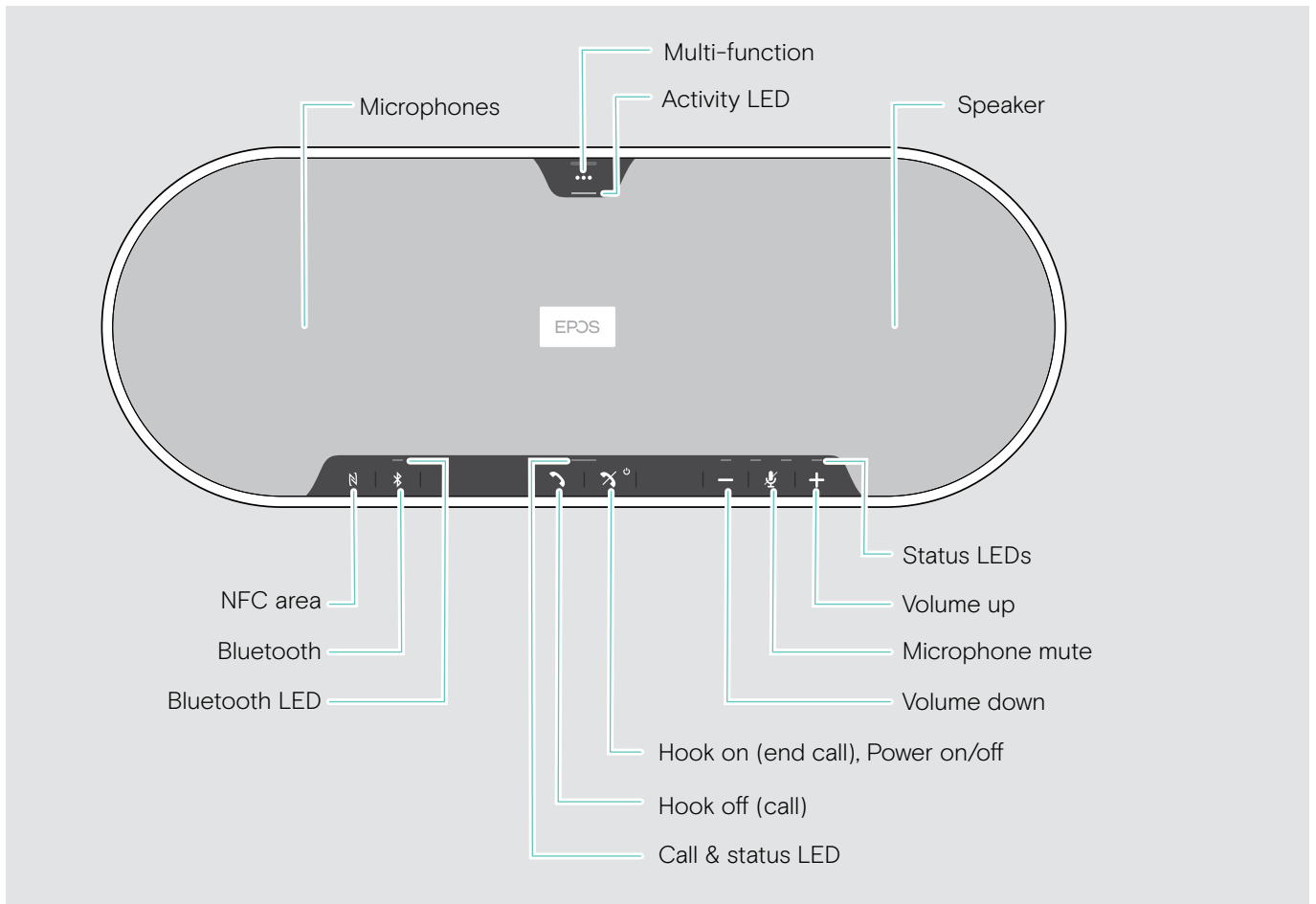



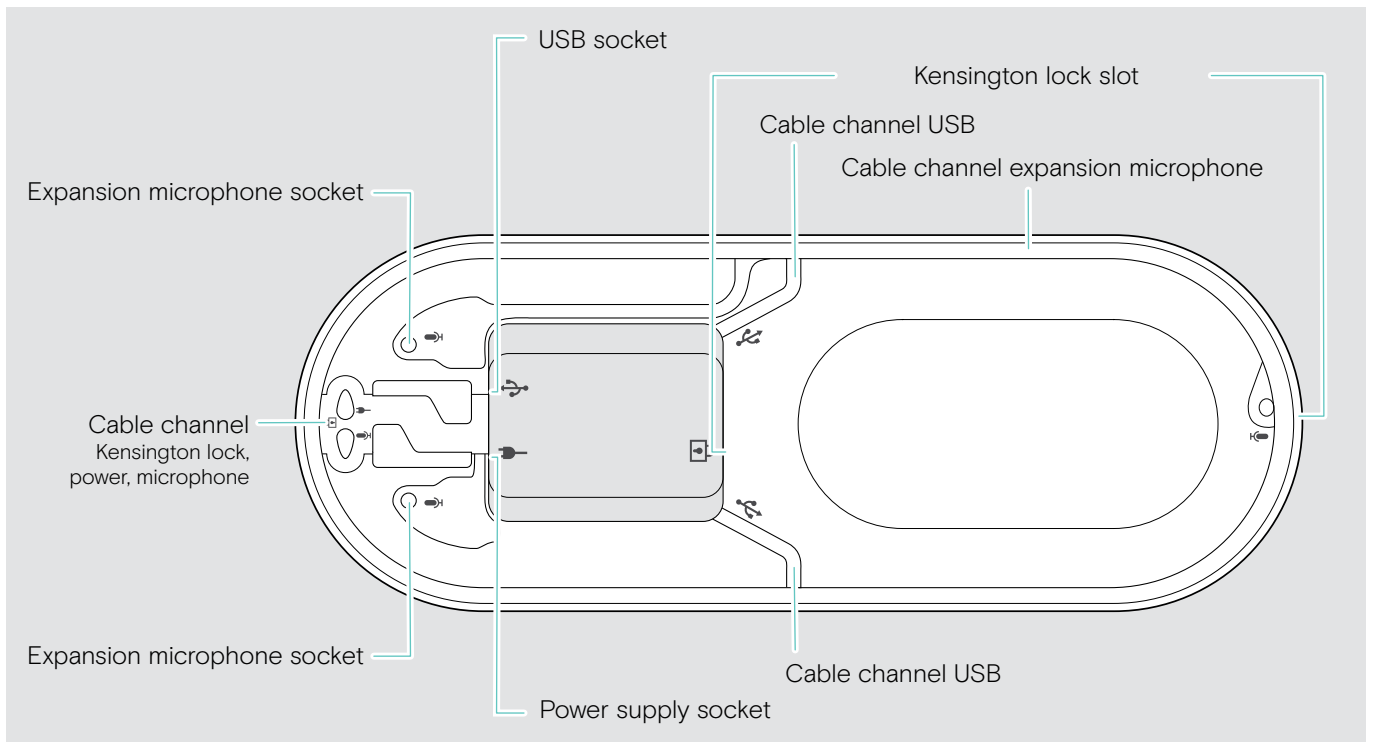



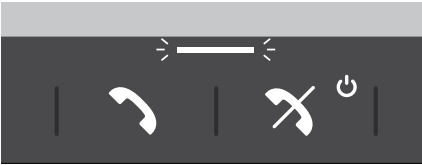



Overview of the speakerphone











Overview of the bottom





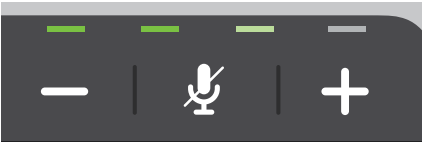





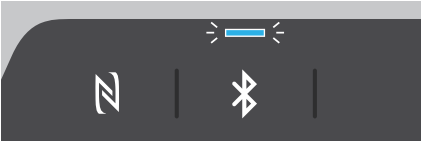

LED overview

Call & status LED	Meaning
	 Speakerphone turned on
	 Speakerphone turning off
	 Speakerphone turned off
	    Incoming call
	 Active call
	 Call on hold
	    Second call on hold

Activity LED	Meaning
	 Media playback
	 Voice assistant activating
	 Voice assistant activated

Status LEDs	Meaning
	 Microphone muted
	  Volume level; eight step indication

Bluetooth LED	Meaning
	    Speakerphone in pairing mode
	 Bluetooth device connected
	 No Bluetooth device connected
	    Searching for paired Bluetooth devices

Overview of the dongle

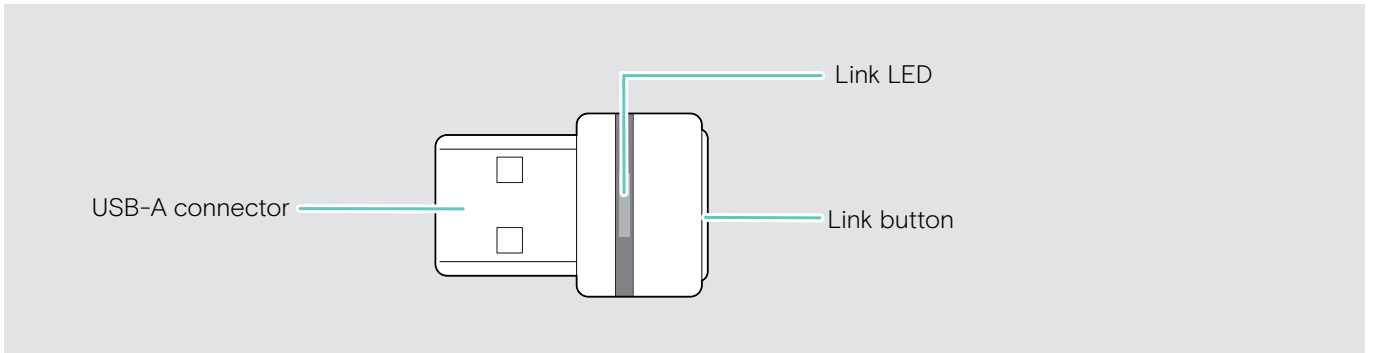

LED overview

	LED	Meaning
	↻ — — — ↻ — — — ↻ — — — ↻ — — —	Dongle in pairing mode: searching for Bluetooth devices to pair and connect
	3x ↻ — — —	Pairing successful
	3x ↻ — — —	Pairing failed
	↻ — — — — — — — — — ↻ — — — — — — — — —	Dongle tries to connect to a Bluetooth device
	↻ — — —	Dongle and Bluetooth device connected
	↻ — — — — — — — — — ↻ — — — — — — — — —	Incoming call
	↻ — — —	<ul style="list-style-type: none"> Outgoing / active call Media playback
	↻ — — — — — — — — — ↻ — — — — — — — — —	Microphone of the connected Bluetooth device is muted

Overview of expansion microphone

The expansion microphone EXPAND 80 Mic is available as an accessory. A list of accessories can be found on the product page at www.eposaudio.com.

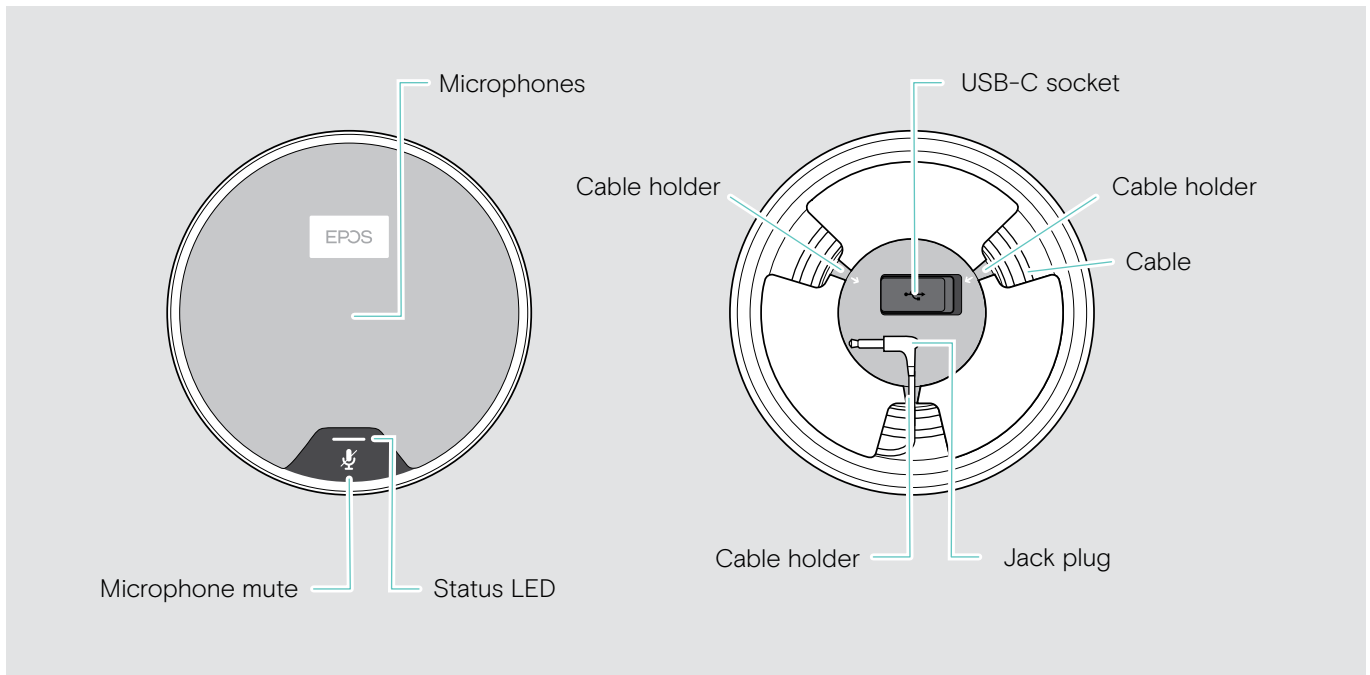

LED overview

	LED	Meaning
	 white dimmed	<ul style="list-style-type: none"> Expansion microphone turned on Media playback
		<ul style="list-style-type: none"> Incoming call
		<ul style="list-style-type: none"> Active call Voice assistant active
		<ul style="list-style-type: none"> Call on hold
		<ul style="list-style-type: none"> Microphone muted

Overview of the icons

	Tap the button		Notes: Good to know
	Press the button twice		LED indications
	Press and hold the button		Voice prompt is announced

Getting started

Positioning the speakerphone and the expansion microphone(s)

You can use the speakerphone in small, medium and large meeting rooms with up to 16 participants.

▷ Place the speakerphone in the middle of the table for optimal sound.

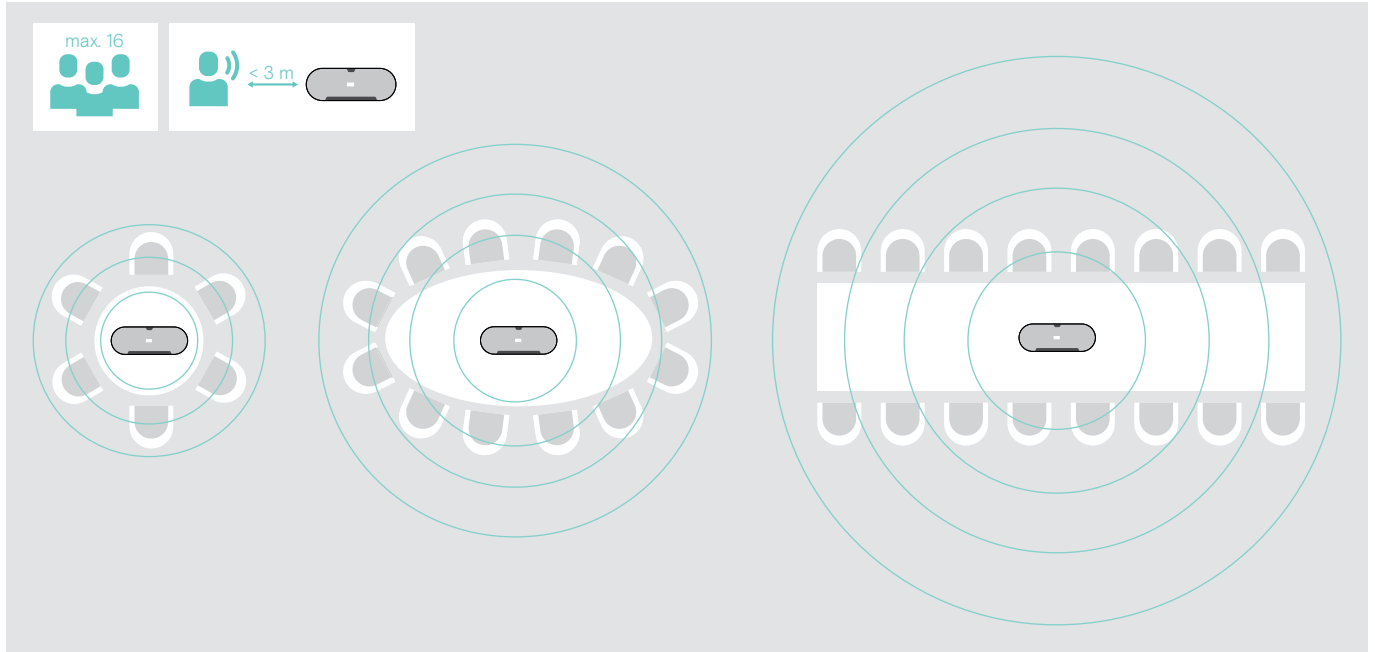

For larger rooms you can connect expansion microphones. With each microphone you can cover up to 8 additional participants.

▷ Place the expansion microphone in the middle of the table and connect it – see next page.

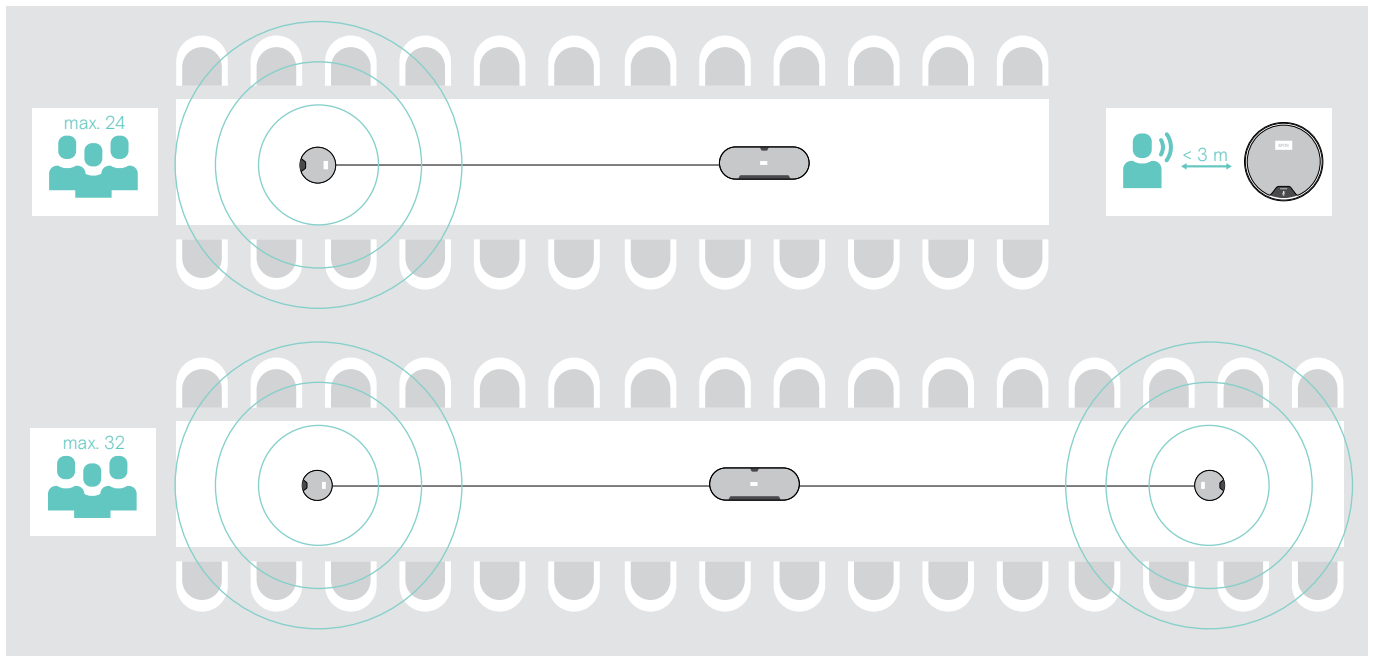

Connecting the expansion microphone(s)

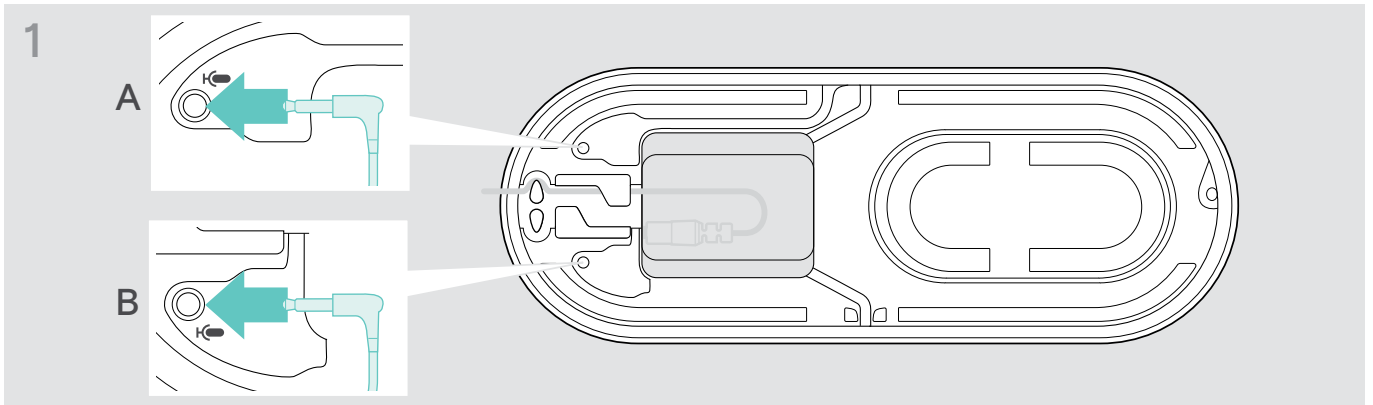

- ▶ Connect the microphone plug to one of the expansion microphone sockets. The expansion microphone turns on or off automatically with the speakerphone.

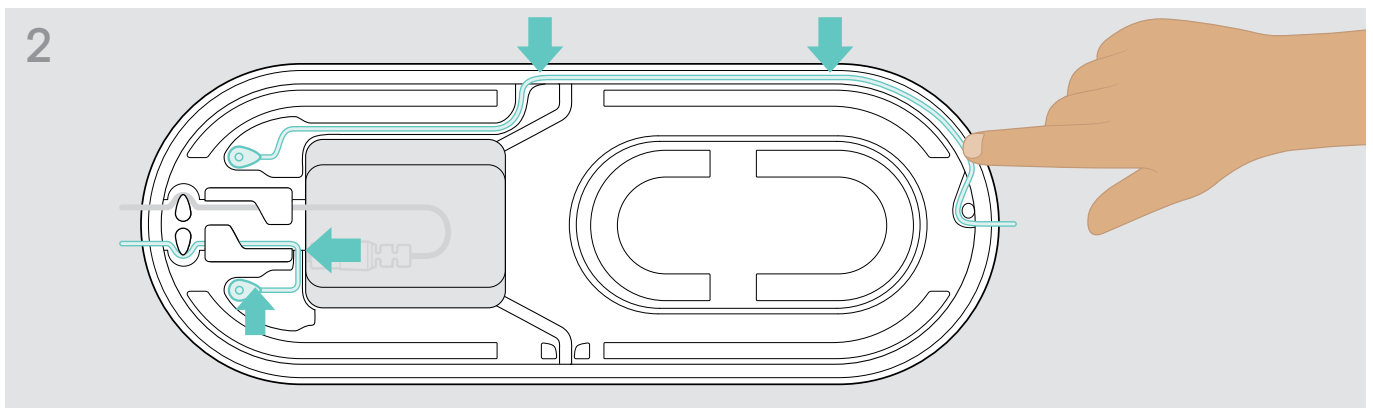

- ▶ Put the cable into the cable channel to secure it.

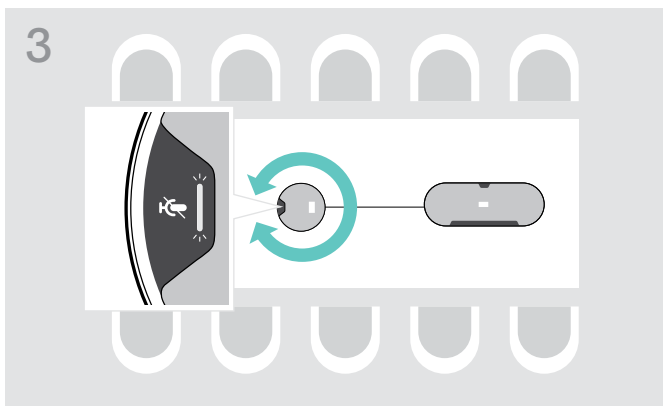

- ▶ Rotate the expansion microphone so that the mute button faces away from the speakerphone.

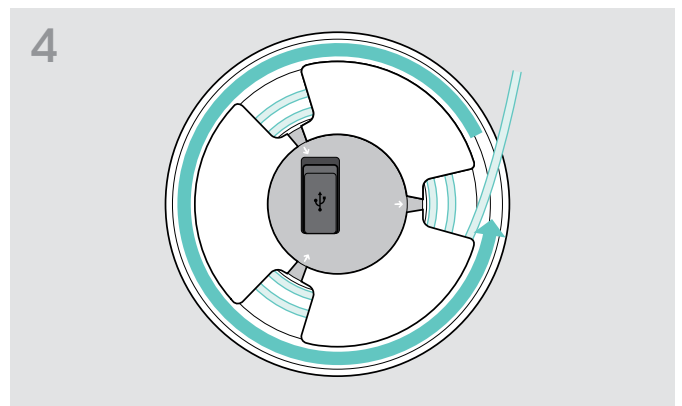

- ▶ Align the cable length on the table and roll up the excess cable.

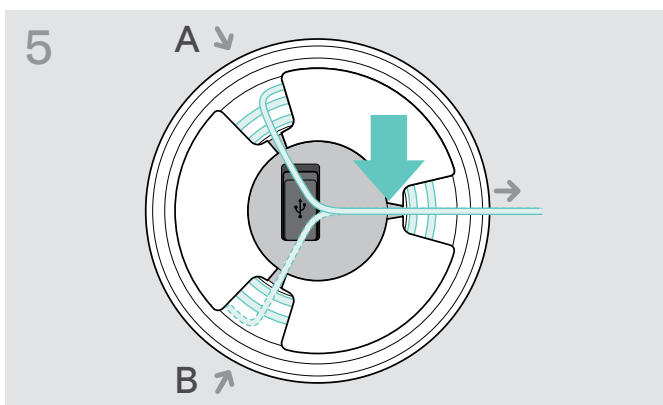

- ▶ Secure the cable in the holders.

Connecting the speakerphone to the mains power supply

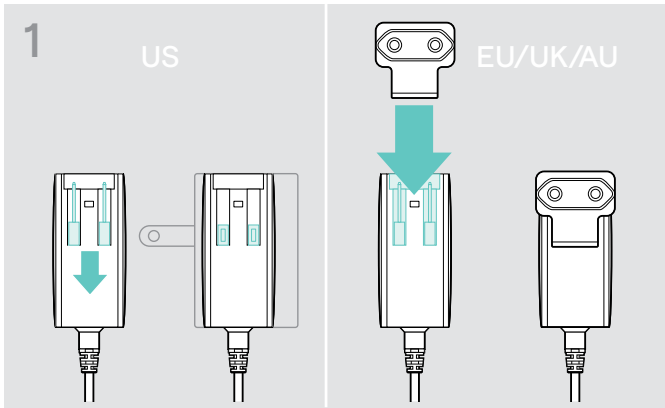

- ▷ US: Flip out the two pins.
- ▷ EU/UK/AU: Select a suitable country adapter and slide it in.

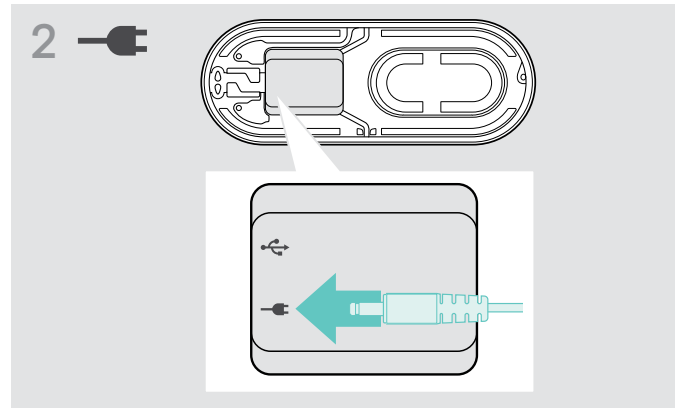

- ▷ Connect the power supply to the power supply socket.

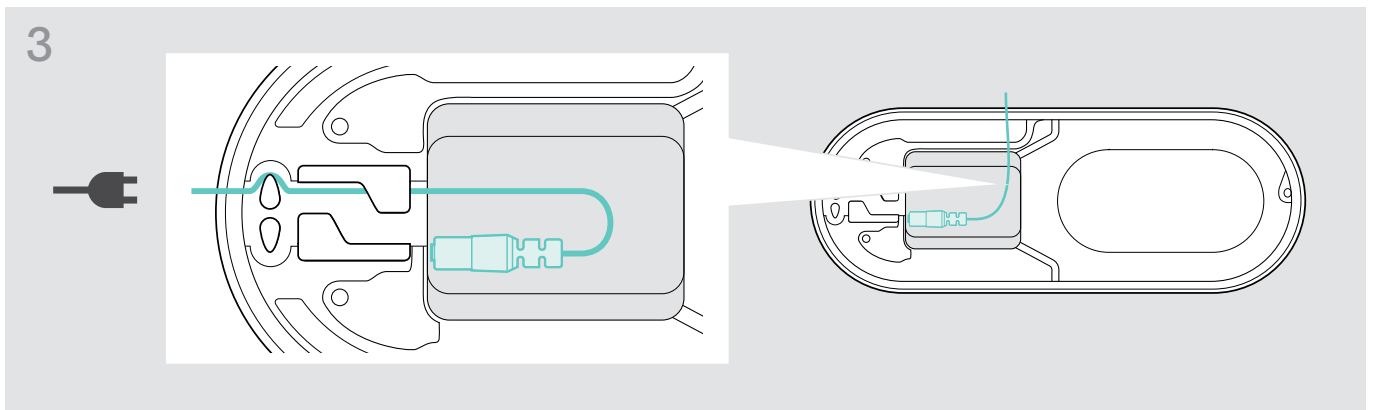

- ▷ Put the cable into the cable channel to secure it.

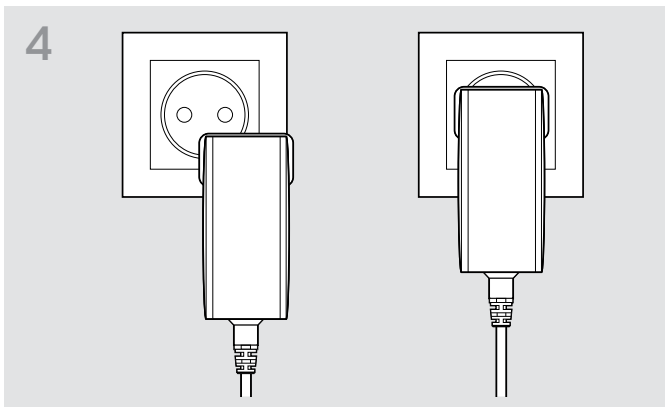

- ▷ Plug the power supply unit into a wall socket.

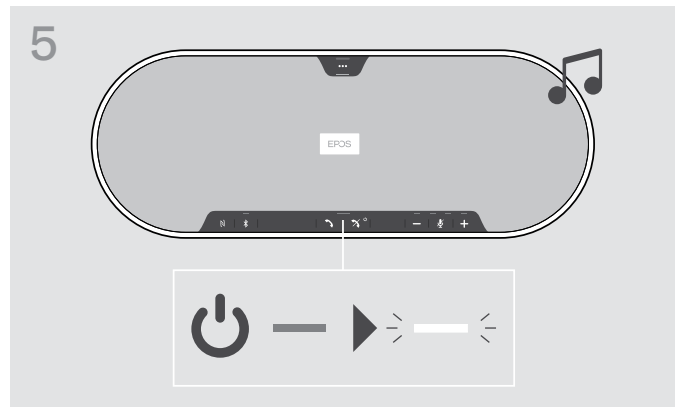

- The speakerphone switches on. The LED lights up white

Connection possibilities

The speakerphone can be connected via:



A: USB cable

B: Bluetooth via NFC

C: Bluetooth

D: Bluetooth via dongle

A: Connecting via USB cable

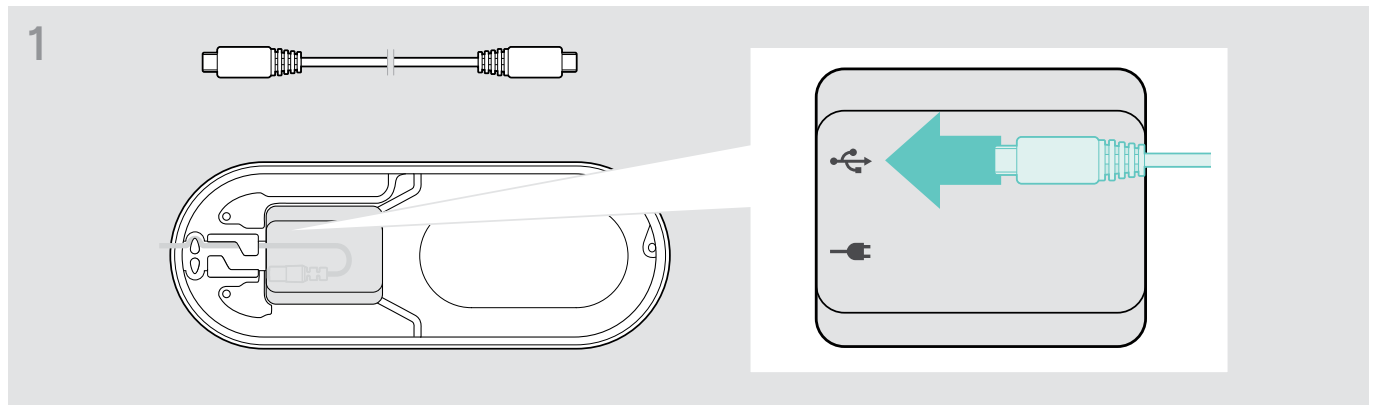

▶ Connect the USB plug to the USB socket.

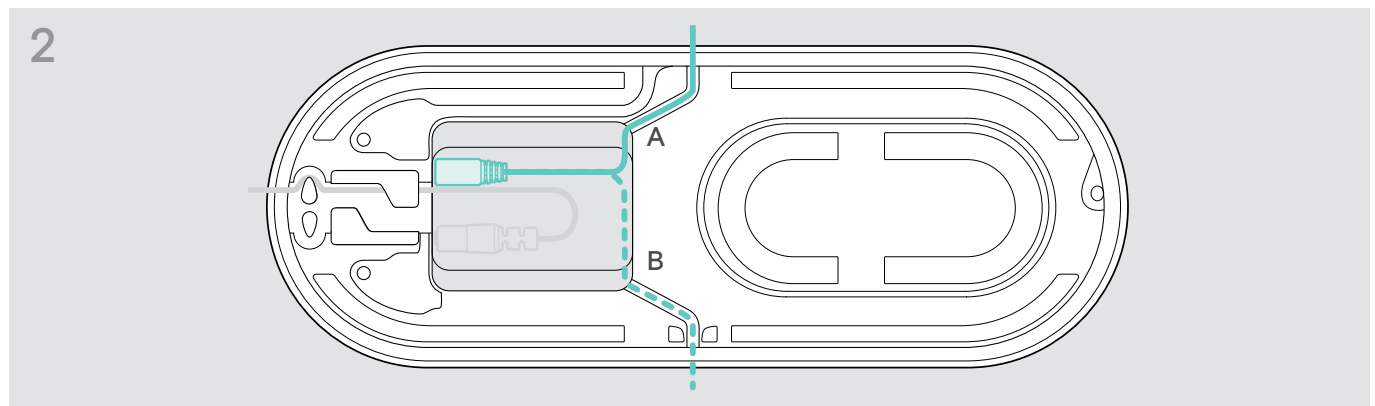

▶ Put the cable into the cable channel (A or B) to secure it.

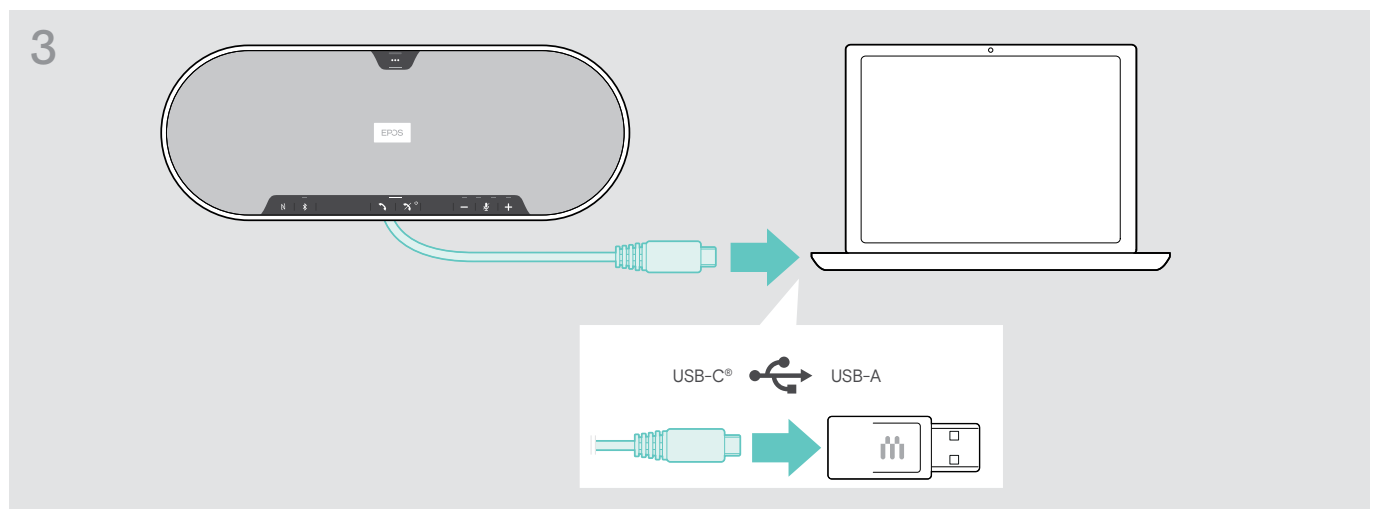

▶ Connect the USB connector directly to a USB-C port or to a USB-A port using the included adapter. The speakerphone turns on automatically. The LED lights up white.

B | C | D About pairing and using with wireless Bluetooth® devices



CAUTION
Danger of malfunction!

The transmitted radio waves of mobile phones can impair the operation of sensitive and unprotected devices.

▷ Only make calls with the speakerphone in locations where wireless Bluetooth transmission is permitted.

The speakerphone complies with the Bluetooth 5.0 standard. In order to transmit data wirelessly, you have to pair your speakerphone with Bluetooth devices that support “hands free profile” (HFP), “headset profile” (HSP) or “advanced audio distribution profile” (A2DP).

The speakerphone can be paired to:

- a mobile device: via NFC™ (B, see page 14) or via Bluetooth (C, see page 15) or
- the BT-D 800 USB dongle: via Bluetooth (D, see page 16).

The speakerphone can be set to personal or shared mode (see page 27). The default setting is shared mode. In this mode pairing must be performed every time when connecting a device via Bluetooth.

Default functionality (shared mode):

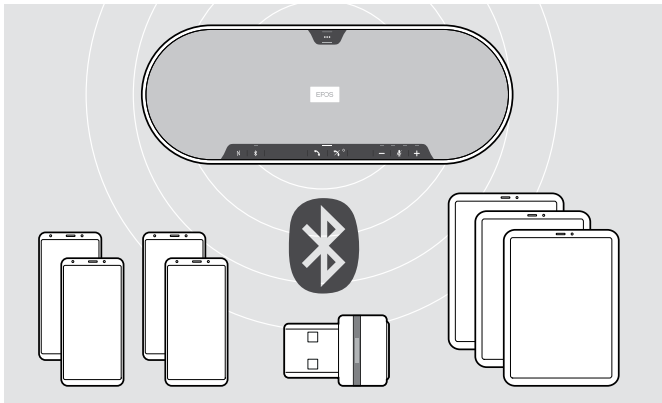

The speakerphone can save up to eight paired Bluetooth devices. If you pair the speakerphone with a ninth Bluetooth device, the saved connection profile of the least recently used device will be overwritten. If you want to re-establish a connection with this device, you have to pair the speakerphone again.

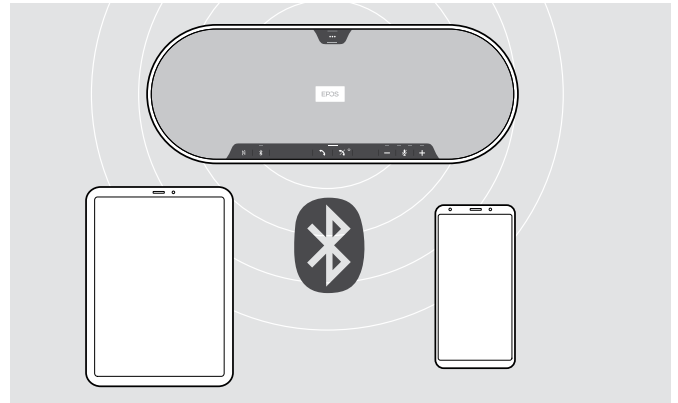

The speakerphone can be wirelessly connected to two devices at the same time.

You can only connect another device by disconnecting one of the already connected devices.

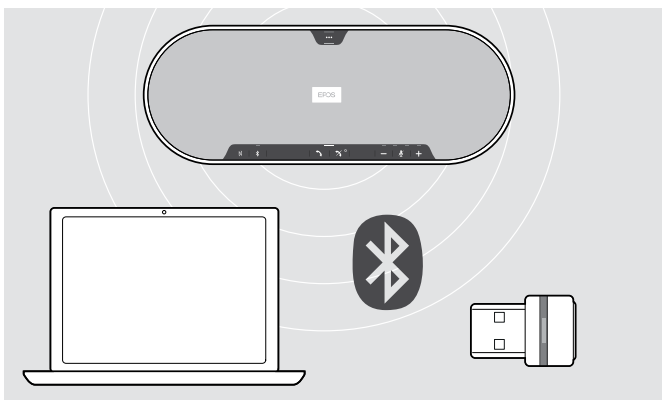

The speakerphone can be used wirelessly with a computer.

You can use:

- the computer's built in Bluetooth functionality or
- the BT-D 800 USB dongle.

B: Pairing the speakerphone and a mobile device via NFC™

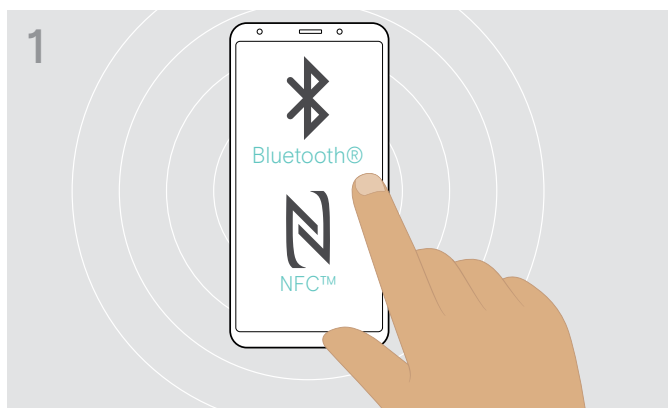

▶ Activate Bluetooth and NFC (Near Field Communication) on your mobile device – see instruction manual of your mobile device.

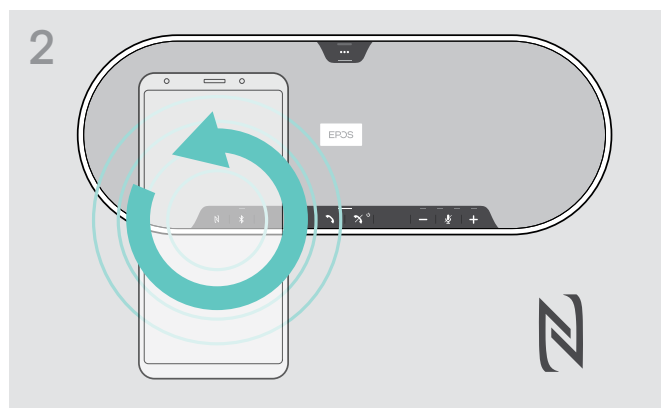

▶ Move the mobile device in small circles directly above the NFC area of the speakerphone.

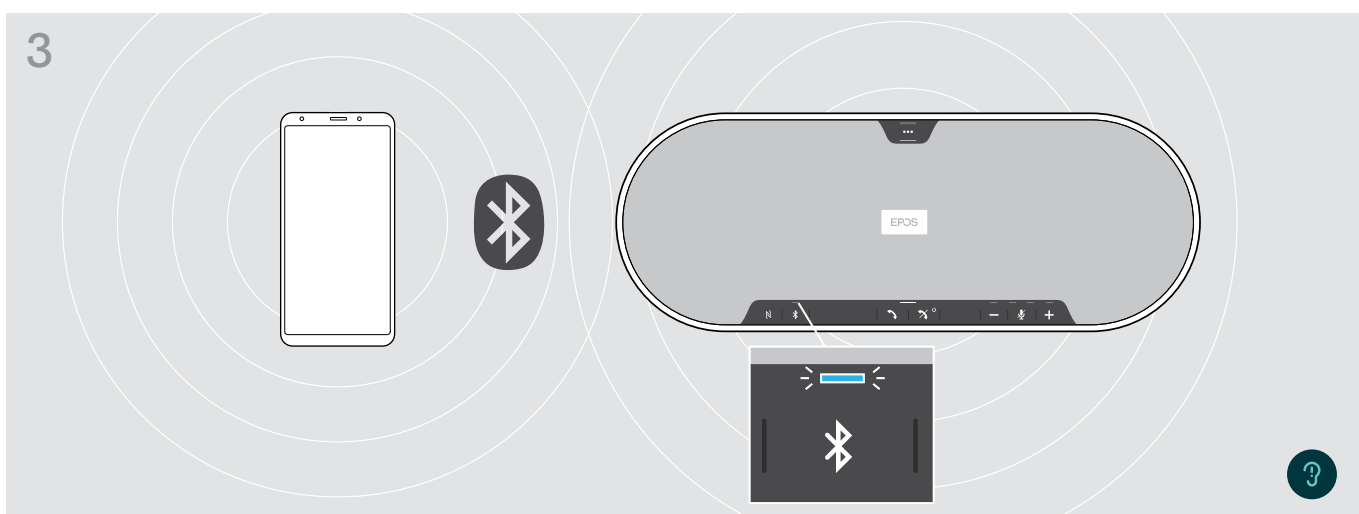

Once the speakerphone is paired with the mobile device, the LED lights up blue.



If required: Confirm the speakerphone on your mobile devices.

C: Pairing the speakerphone and a mobile device via Bluetooth®

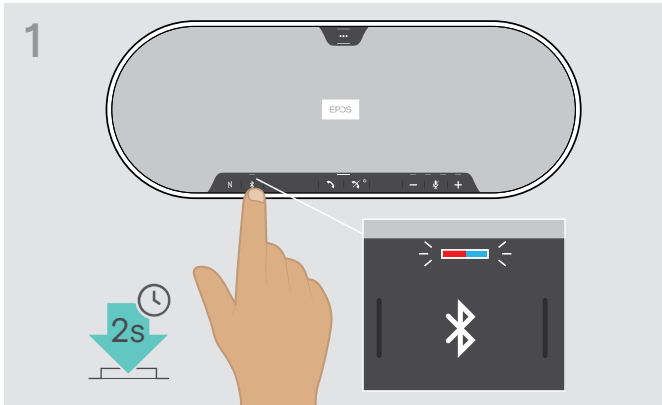

- ▶ Press and hold the Bluetooth button until the LED flashes blue and red. The speakerphone is in pairing mode.



- ▶ Enable the Bluetooth visibility on your mobile device – see instruction manual of your mobile device.
- ▶ Start a search for Bluetooth devices. All available devices in the proximity of the mobile device are displayed.



- ▶ Select “EPOS EXPAND 80”* to establish a Bluetooth connection to the speakerphone.
* You can change the default name via [EPOS Connect](#).

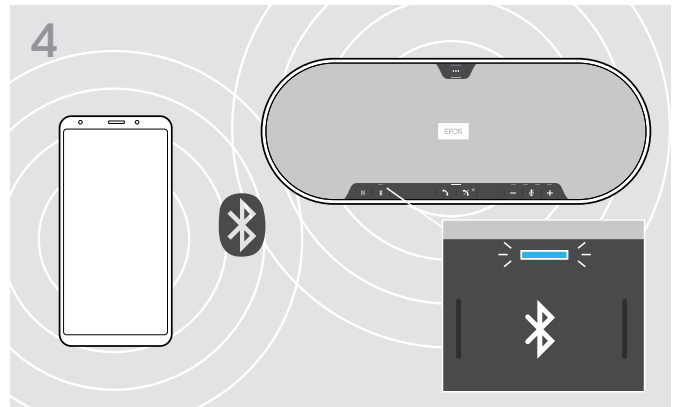

Once the speakerphone is paired with the mobile device, the LED lights up blue.

D: Connecting the Bluetooth® dongle to a computer and pairing the speakerphone

To connect the speakerphone wirelessly with a computer, use the BT-D 800 USB dongle. The dongle and the speakerphone in the bundle are already paired.

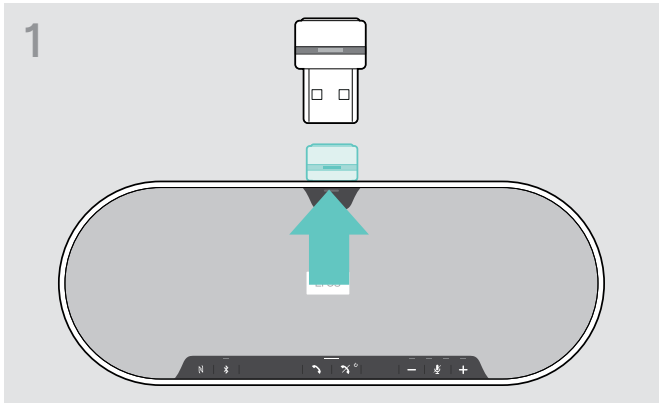

▶ Release the dongle from the storage.

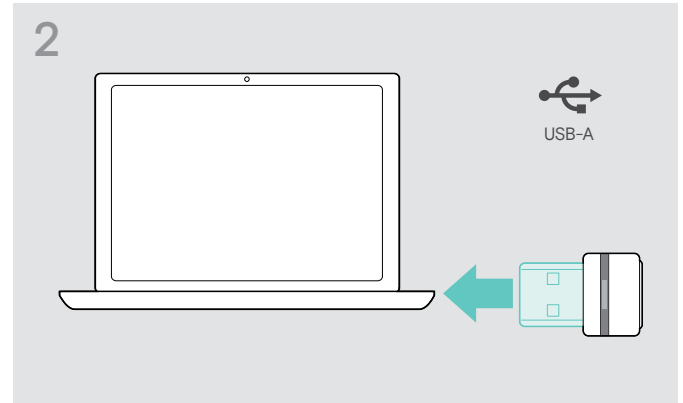

▶ Plug the dongle into the USB port of your computer.

The dongle and speakerphone LED flashes blue while searching.

Once the speakerphone is connected with the dongle, the speakerphone LED lights up blue and the dongle LED switches to dimmed blue.

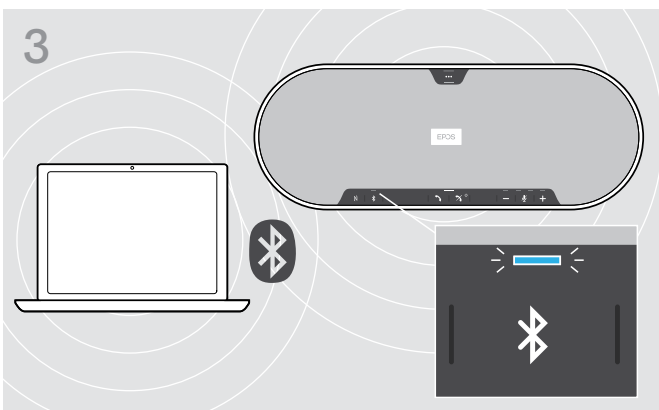

To manually pair the speakerphone and the dongle, activate the pairing mode for both:



▶ Press and hold the speakerphone's Bluetooth button and the dongle's button until the LEDs alternately flash blue and red. Once the dongle and the speakerphone are connected, the speakerphone lights up blue and the dongle lights up dimmed blue.

Installing EPOS software

The free EPOS software allows you to add value to your EPOS products. It enables easy set-up, configuration and update of your speakerphone.

Examples of supported settings and configurations in [EPOS Connect](#):

- Bluetooth on/off,
- Device name
- Personal/shared mode,
- Manage pairing list
- Sounds and notifications including voice prompt language
- Factory reset

[EPOS Connect](#) offers further configurations and additional settings – see options in the software.

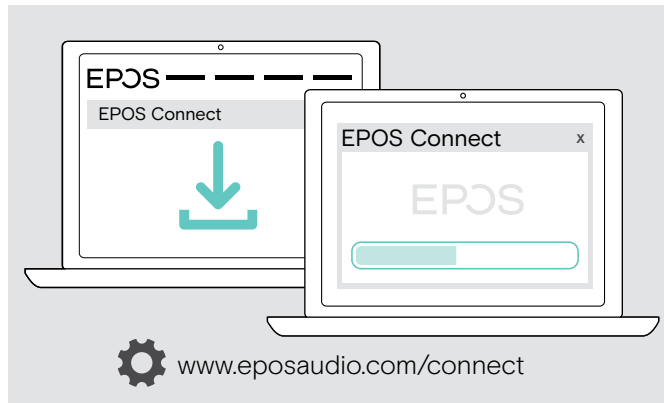

- ▷ Download the software from www.eposaudio.com/connect.
- ▷ Install the software.
You need administrator rights on your computer – if necessary, contact your IT department.

To make calls via the computer:

- ▷ Install a softphone (VoIP Software) or ask your admin for support.

Changing Audio settings for the speakerphone – Microsoft® Windows

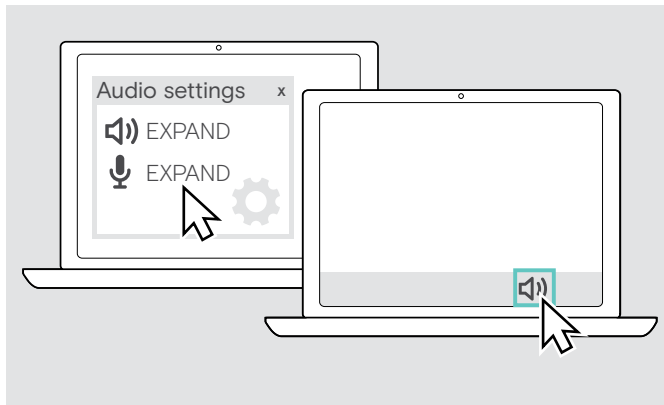

Windows usually changes the Audio settings automatically if you connect a new device.

If the speakerphone is connected but you hear no sound:

- ▷ Right-click the Audio icon.
- ▷ Select under output EXPAND 80 as speaker.
- ▷ Select under input EXPAND 80 as microphone.

Using the speakerphone

Turning the speakerphone and the expansion microphone(s) on

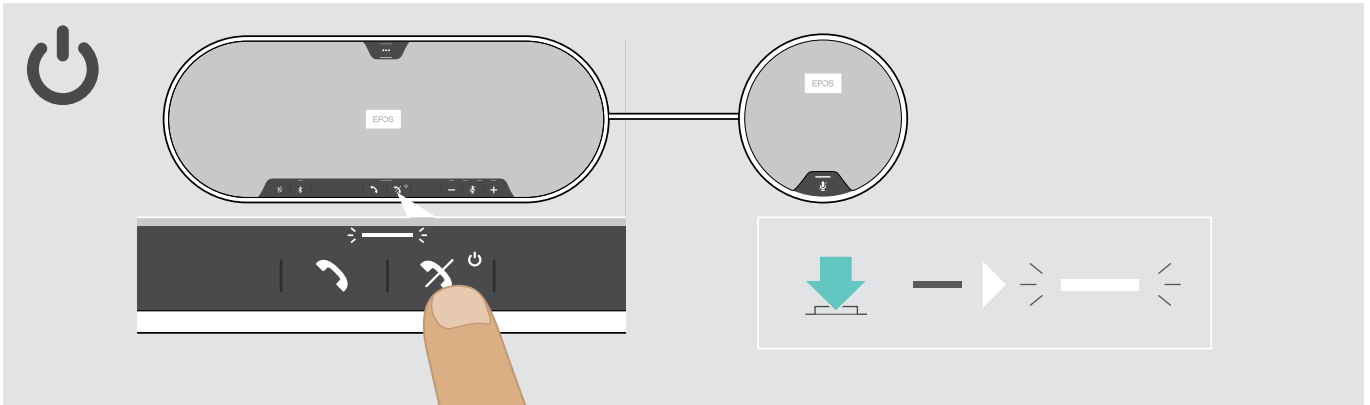

- ▶ Press the Power on/off button.
The LED lights up white. The expansion microphone turns on automatically and the LED lights up dimmed.

Connecting / disconnecting Bluetooth® devices

Connecting Bluetooth devices

Depending on the setting for personal/shared mode (see page 27).

A: Shared mode

The speakerphone is by default in shared mode. In this mode pairing must be performed every time when connecting a device via Bluetooth.

- **B NFC** see page 14 or
- **C Bluetooth** see page 15 or
- **D Dongle** see page 16

B: Personal mode

The speakerphone will by default attempt to connect to the two last connected Bluetooth devices.

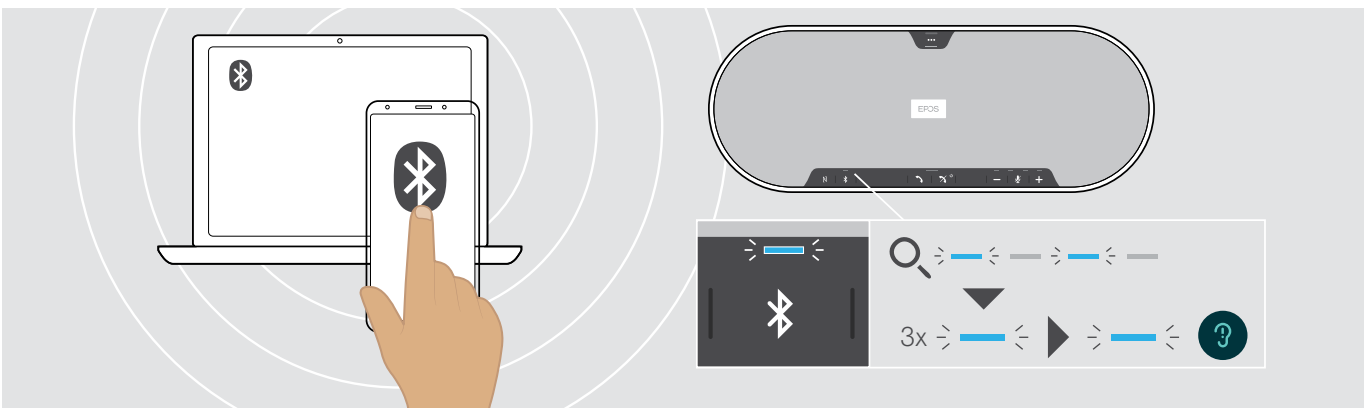

- ▶ Activate Bluetooth on the paired device(s).
The LED flashes blue while the speakerphone attempts to connect to previously paired Bluetooth device(s). Once the connection is successfully established, the LED lights up blue.

If the Bluetooth LED does not flash blue (automatic search after switch-on):

- ▶ Press the Bluetooth button to connect manually.



Only two out of the maximum eight paired Bluetooth devices can be simultaneously connected to the speakerphone.

The search for paired devices will timeout if no devices are found. After this, connections must be established manually on the paired Bluetooth device or by pressing the Bluetooth button on the speakerphone

Disconnecting Bluetooth device(s)

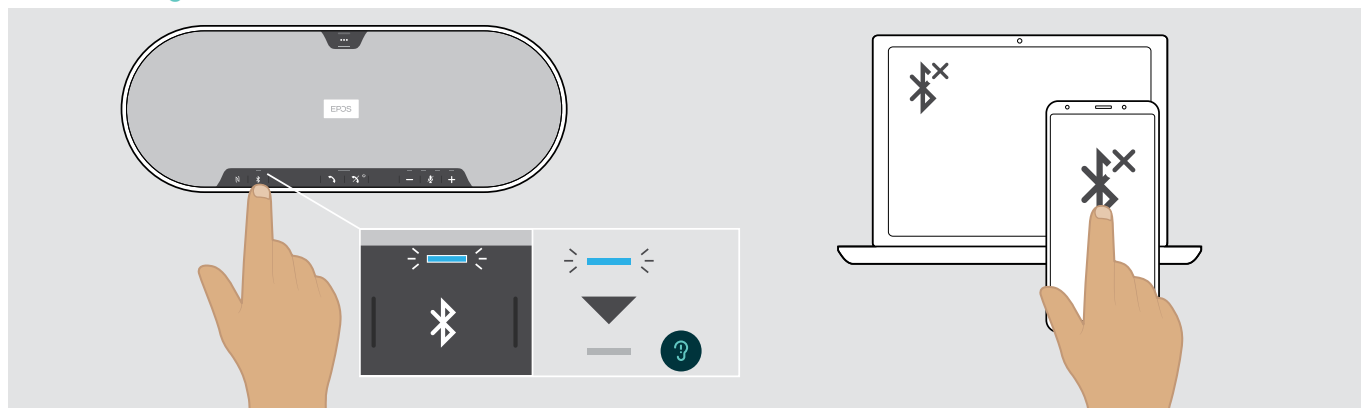

▷ Press the Bluetooth button. The LED turns off. **OR** Deactivate Bluetooth on the connected device.

To re-connect paired Bluetooth devices (personal mode only):

▷ Press the button again.

Turning the speakerphone and the expansion microphone(s) off

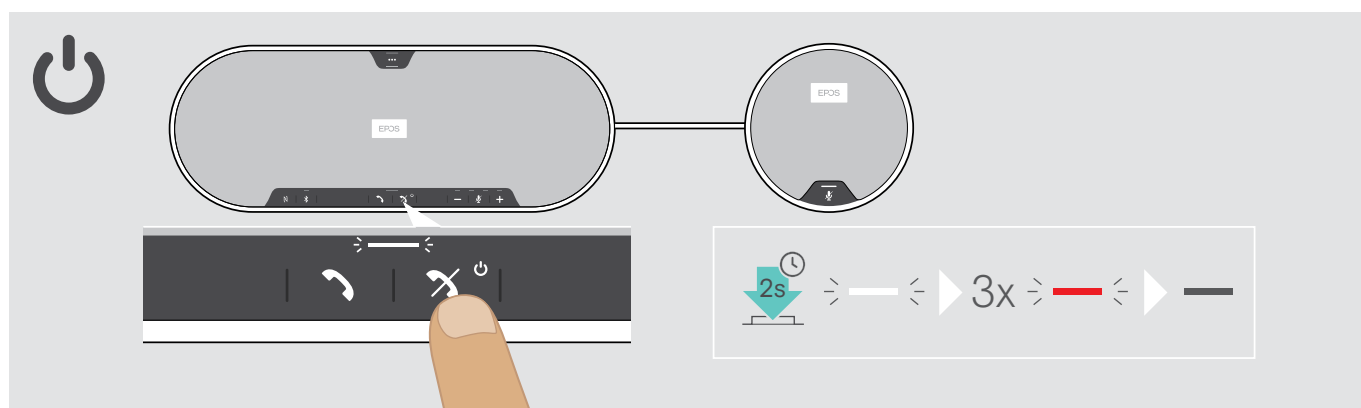

▷ Press and hold the Power on/off button.

The LED flashes red 3 times and turns off. All volume settings are saved. The expansion microphone turns off.

Adjusting the volume

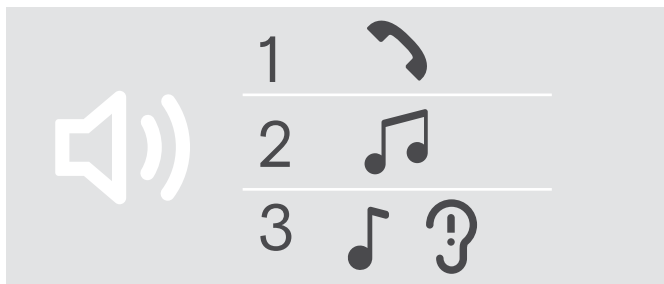

You can adjust three independent volume settings for the speakerphone:

1. Call volume: during an active call
2. Audio volume: during audio streaming
3. Volume for ring tone, tones and voice prompts: in idle mode – no active call or audio streaming

Increasing the volume

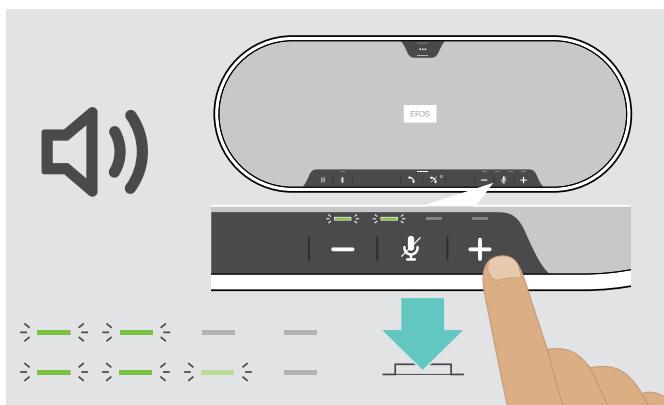

▷ Press the button +

LEDs and volume will be increased or reduced by half step with each button press.

Decreasing the volume

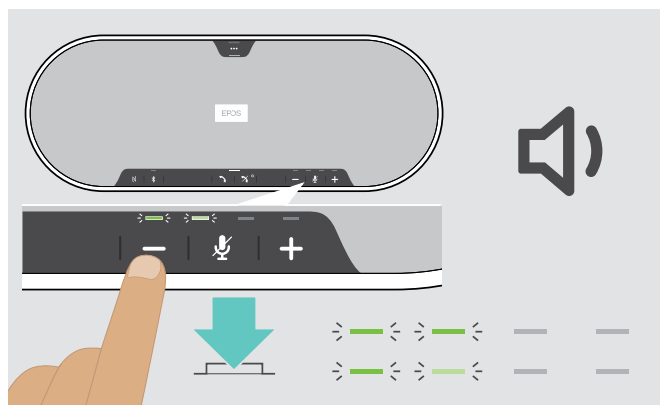

▷ Press the button -

Muting the microphone(s)

Muting the microphone



▷ Press the Microphone mute button.
The LEDs light up red.

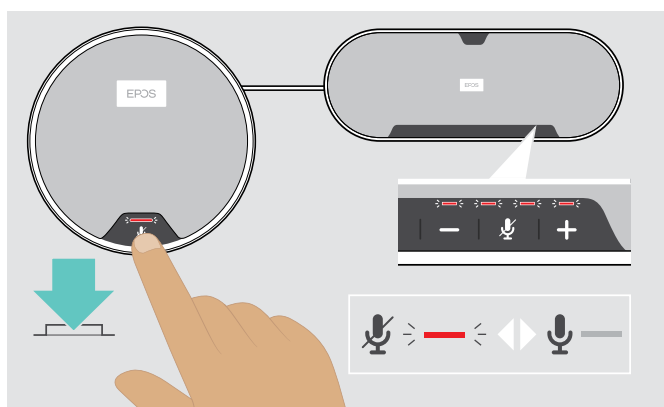

Unmuting the microphone



▷ Press the button again.
The LEDs turn off.

If you use one or two expansion microphone(s):

- ▷ Press the Microphone mute button on the speakerphone or on the expansion microphone. All microphones will be muted or unmuted.

Making calls using the speakerphone

Making a call

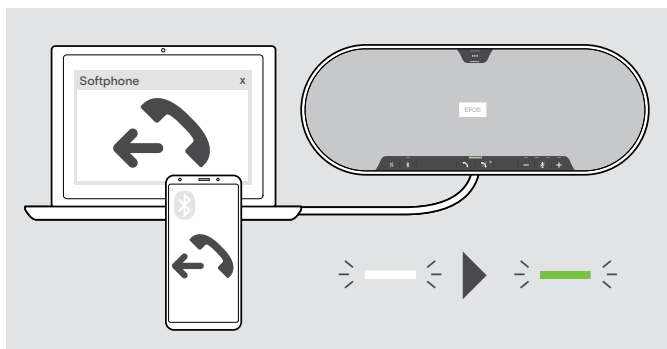

- ▶ Initiate the call on your connected device. The LED lights up green.

If your call is not automatically transferred to the speakerphone:

- ▶ Press the speakerphone's hook off button , or use call transfer functionality on the mobile device.



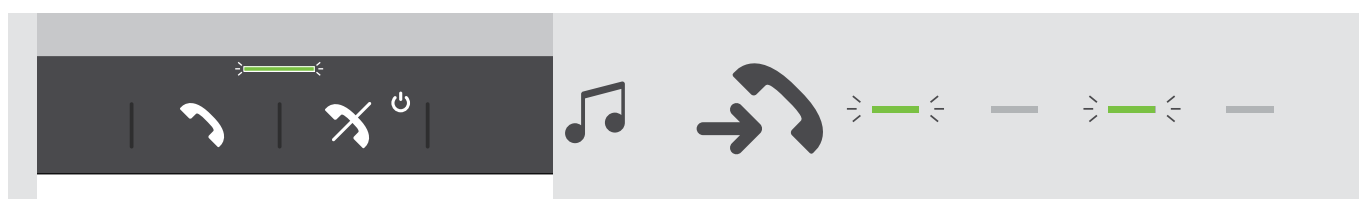



Accepting/rejecting/ending a call



When you receive a call: You hear a ring tone and the LED flashes green.







Accept/hold a call



	 Accepts a call
LED	
	 Puts an active call on hold (pause)
LED	







Reject/end a call

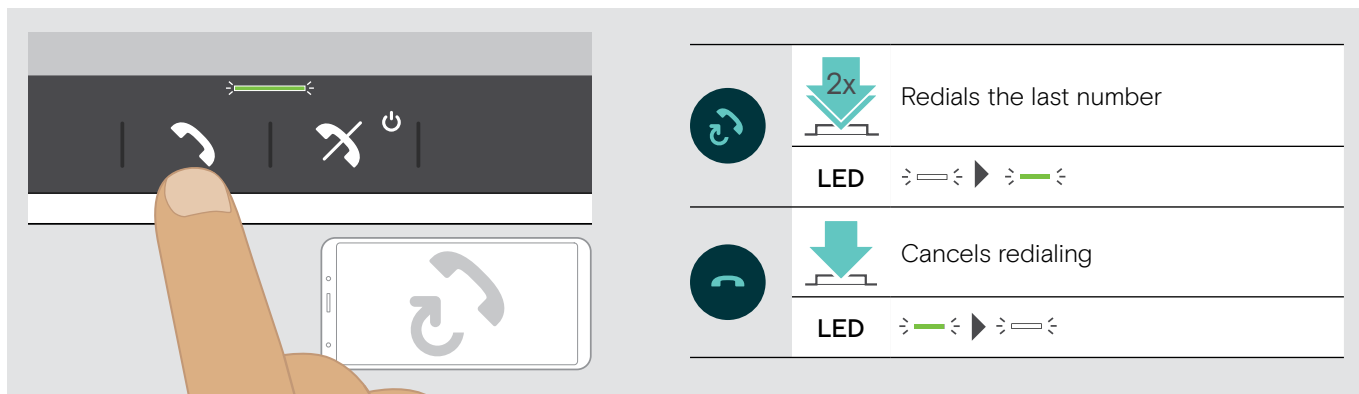

	 Rejects a call
LED	
	 Ends a call
LED	

Redialing





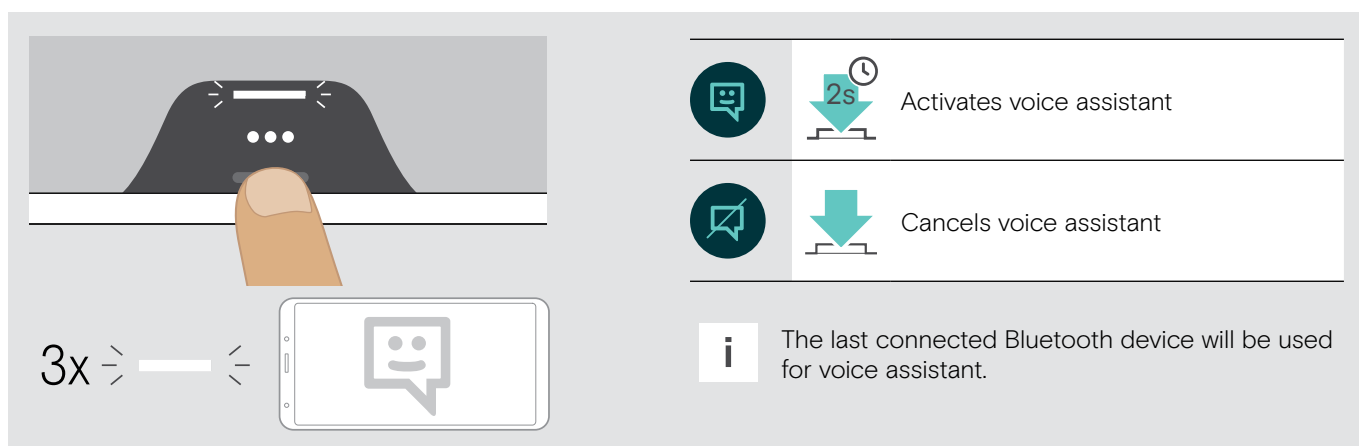

	 Redials the last number
	LED 
	 Cancels redialing
	LED 

Using the voice assistant

Voice assistant will only be supported for device(s) connected via Bluetooth. Available functionality depends on the connected device.



	 Activates voice assistant
	 Cancels voice assistant

i The last connected Bluetooth device will be used for voice assistant.

Managing multiple calls

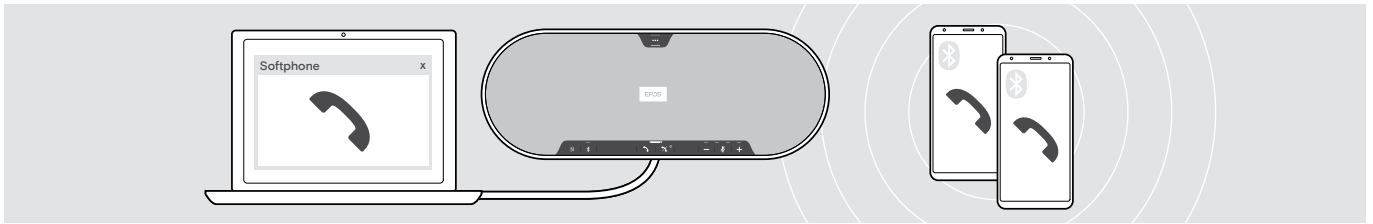

You can use the speakerphone with up to three connected devices, one connected via USB and two via Bluetooth. Two calls can be managed simultaneously. If you receive a call during an active call, a knock on tone will be played.

Accept second call

Active call **2nd incoming call**

Accepts the incoming call and puts the active call on hold

LED > ● < — > ● < — ▶ > ● < > ● < > ● < > ● <

Reject second call

Active call **2nd incoming call**

Rejects the incoming call and continues the active call

LED > ● < — > ● < — ▶ > ● < > ● <

Toggle between calls

The diagram illustrates the process of toggling between an active call on a mobile phone and a second held call on a laptop softphone. On the left, a smartphone icon is labeled "Active call" and a laptop icon is labeled "2nd held call". The laptop screen shows a "Softphone" window with a call icon. On the right, a close-up of the speakerphone's touch interface shows a finger tapping a call icon. Below this, a row of call status icons shows a green call icon with a double bar (active) and a red call icon with a single bar (held). A text box with a downward arrow states: "Toggles between the active and held call". Below the text box, an LED indicator sequence shows a green bar followed by a red bar, with a right-pointing arrow indicating the transition.

Active call 2nd held call

Toggles between the active and held call

LED

End call

The diagram illustrates the process of ending an active call on a mobile phone and making a held call on a laptop softphone active. On the left, a smartphone icon is labeled "Active call" and a laptop icon is labeled "2nd held call". The laptop screen shows a "Softphone" window with a call icon. On the right, a close-up of the speakerphone's touch interface shows a finger tapping a call icon. Below this, a row of call status icons shows a red call icon with a single bar (held) and a green call icon with a single bar (active). A text box with a downward arrow states: "Ends the active call and makes the held call active". Below the text box, an LED indicator sequence shows a red bar followed by a green bar, with a right-pointing arrow indicating the transition.

Active call 2nd held call

Ends the active call and makes the held call active

LED

Merging calls – Conference

Two calls – one via USB, the other via Bluetooth – can be merged in a conference.

Merge/unmerge calls

Active call	2nd held call	
		<p> Merges the active call and the held call</p> <p>LED </p>
		<p> Unmerges the calls; puts the previously held call on hold again</p> <p>LED </p>

End merged calls

Call 1	Merged call 2	
		<p> Ends all calls</p> <p>LED </p>

Listening to music using the speakerphone – media playback

You can listen to media playback via USB or Bluetooth connected device.

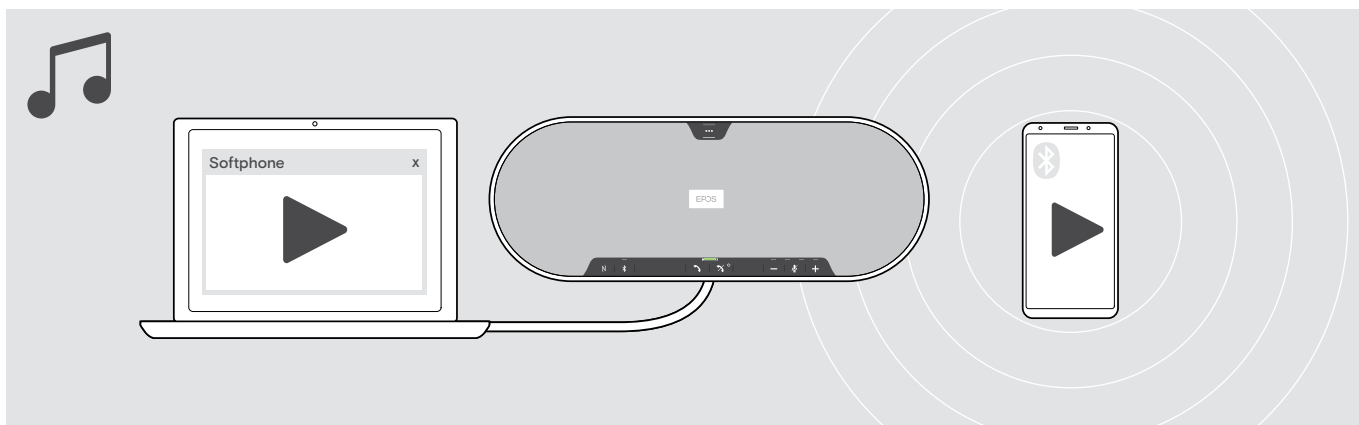

Control active media playback

A diagram showing a hand interacting with the speakerphone's touch controls. The speakerphone has a purple bar and three dots on its top surface. Below it, a hand is shown touching a play button icon. To the right, a table lists the actions for each touch control.

		Plays audio
		Pauses audio
		Skips to the next track

i If you receive and accept a call, media playback is paused and restarts after the call – if supported by the connected device.

Good to know

Switching between Bluetooth® personal and shared mode

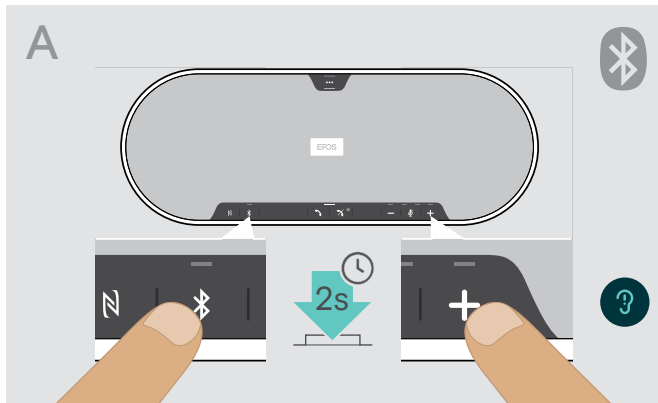

Activating Personal mode

If the speakerphone is used as a **personal device** it will automatically attempt to connect to the last eight paired devices.

In this setup the **Personal Mode** should be used.

- ▷ Press the Bluetooth and + button.
A voice prompt is announced.

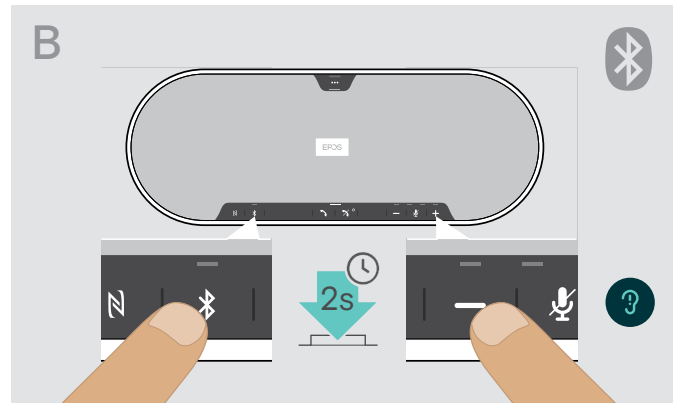

Activating Shared mode

If the speakerphone is used as a **shared device** automatic connection to previously paired devices may not be desired.

In this setup the **Shared Mode** (default) should be used. In this mode pairing must be performed every time when connecting a device via Bluetooth.

- ▷ Press the Bluetooth and - button.
A voice prompt is announced.



After change of mode, the pairing list is cleared and you have to pair devices again (see page 16).

Waking up from standby

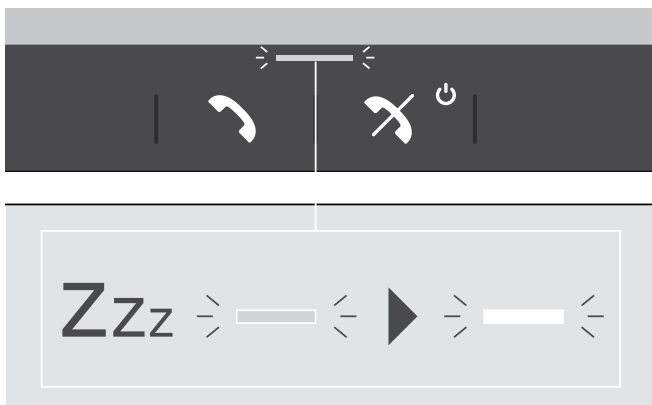

The speakerphone enters standby mode automatically after some time to save energy – depends on connection status, activity etc.

While in standby the Call & status LED is dimmed and all other LEDs are off.

- ▷ Press any button to end the standby mode.

Enabling / disabling voice prompts

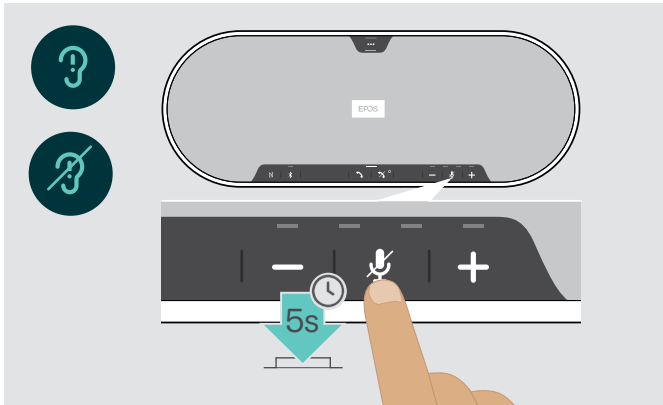

In idle mode (no active call or music reproduction):

- ▶ Press and hold the mute button until the speakerphone announces a voice prompt for on or off.

If the voice prompts are deactivated you hear tones instead.



You can also change this setting via EPOS Connect.

Using an optional Kensington® lock

You can secure your speakerphone e. g. on a table of a meeting room with an optional Kensington lock.

You can connect the Kensington lock both **inside A** or **outside B** the product.

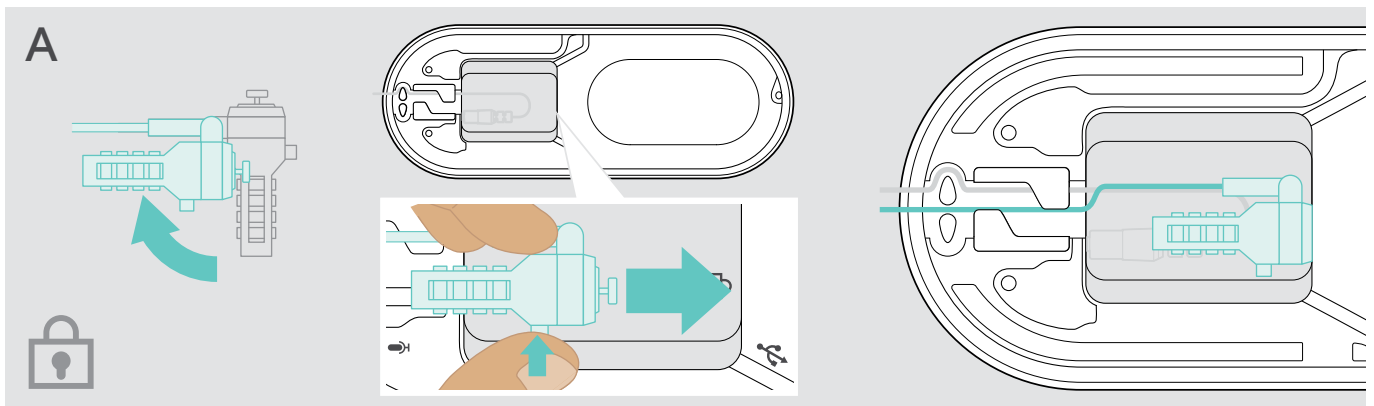

The Kensington lock slot inside the speakerphone is optimized for combination locks with T-bar interface and wire with less than \varnothing 5 mm.

- ▶ Mount the cable – see instructions of Kensington lock.
- ▶ Rotate the lock and insert into the Kensington slot.
- ▶ Put the cable into the cable channel to secure it.

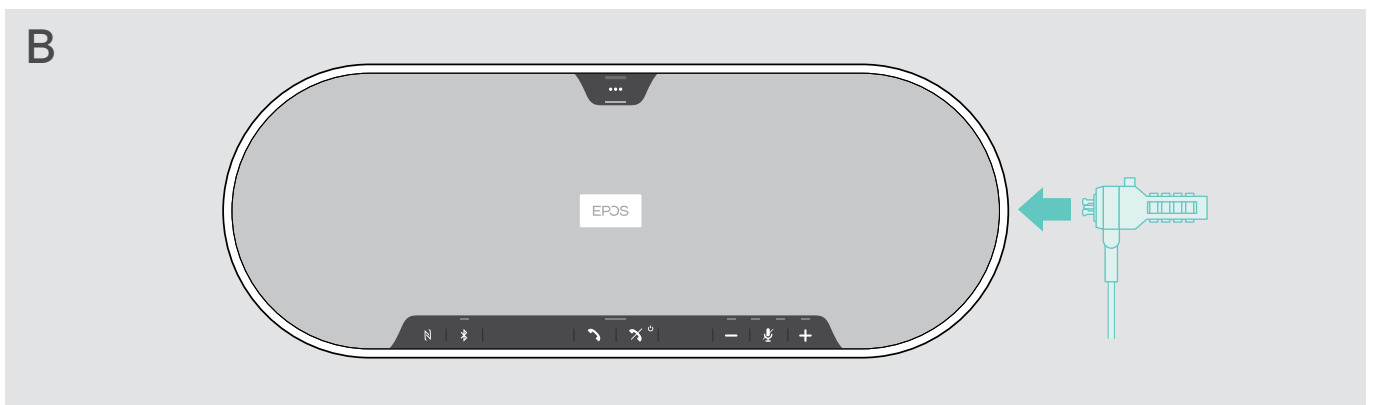

The Kensington slot outside the product supports most common Kensington locks.

- ▶ Mount the cable – see instructions of Kensington lock.
- ▶ Insert the lock into Kensington slot.

Bluetooth® transmission range

Calling and media playback is only possible in the Bluetooth transmission range of the devices. The transmission range largely depends on environmental conditions such as wall thickness, wall composition etc. With a free line of sight, the transmission range of most mobile phones and Bluetooth devices is up to 25 meters.

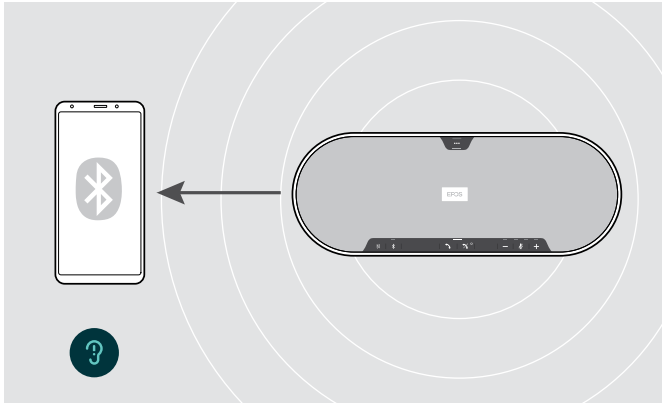

If you leave the Bluetooth transmission range, the audio quality deteriorates first and later connected devices will be disconnected.

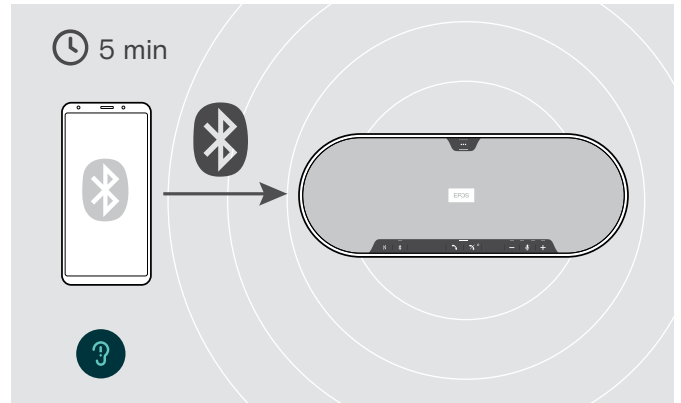

If you re-enter the Bluetooth transmission range **within short period of time**, the speakerphone will attempt to restore the connection(s) – in personal mode only.

If you spend **a longer period of time** outside the Bluetooth transmission range:

- ▶ Press the Bluetooth button to connect manually.

Storing the dongle and the expansion microphone

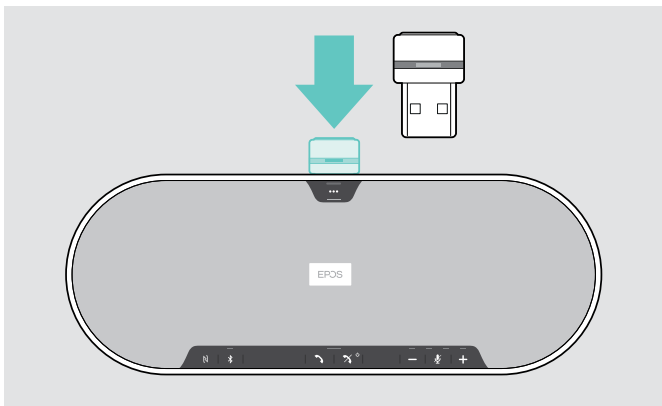

- ▶ Place the dongle in the storage slot.

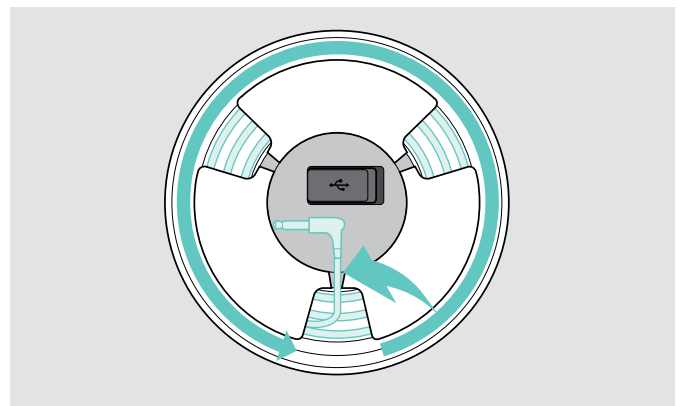

- ▶ Disconnect the plug from the speakerphone.
- ▶ Unlock the cable from the holders, roll it up and fix it in the holder.

Maintaining and updating the products

Cleaning the products

CAUTION

Liquids can damage the electronics of the product!

Liquids entering the housing of the device can cause a short circuit and damage the electronics.

- ▷ Keep all liquids far away from the product.
- ▷ Do not use any cleansing agents or solvents.
- ▷ Do not vacuum clean the top cover of the product.

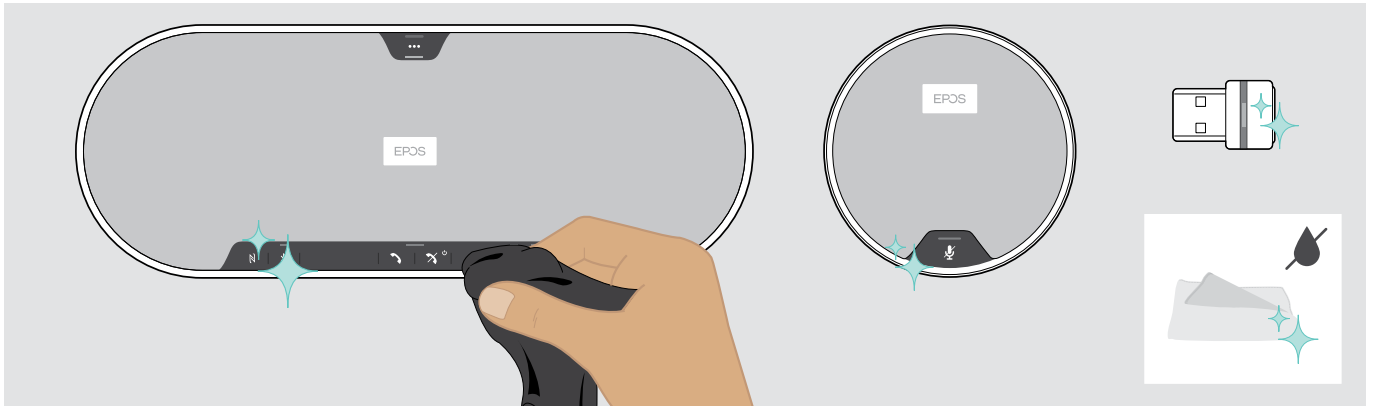

- ▷ Before cleaning, disconnect the speakerphone from the mains power supply.
- ▷ Only use a dry cloth to clean the product.
- ▷ Clean the fabric with a lint roller.

Updating the firmware of the products

You can update the firmware of your speakerphone, expansion microphone and dongle by using the free **EPOS Connect** software.

- ▷ Download the software from www.eposaudio.com/connect.
- ▷ Install the software.
To install the software, you need administrator rights on your computer. If necessary, contact your IT department.

Updating the firmware of the speakerphone

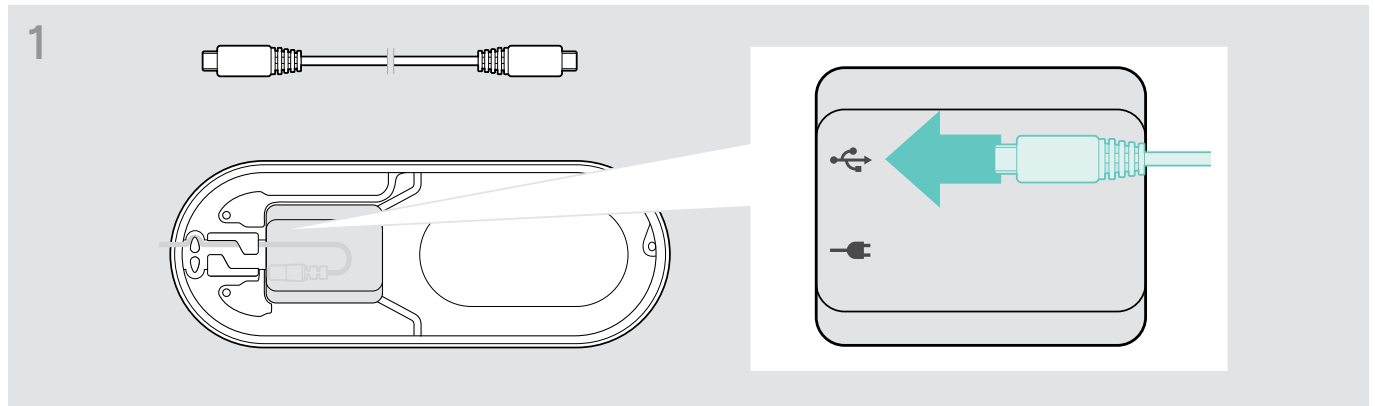

- ▷ Connect the USB connector to the USB socket at the bottom.

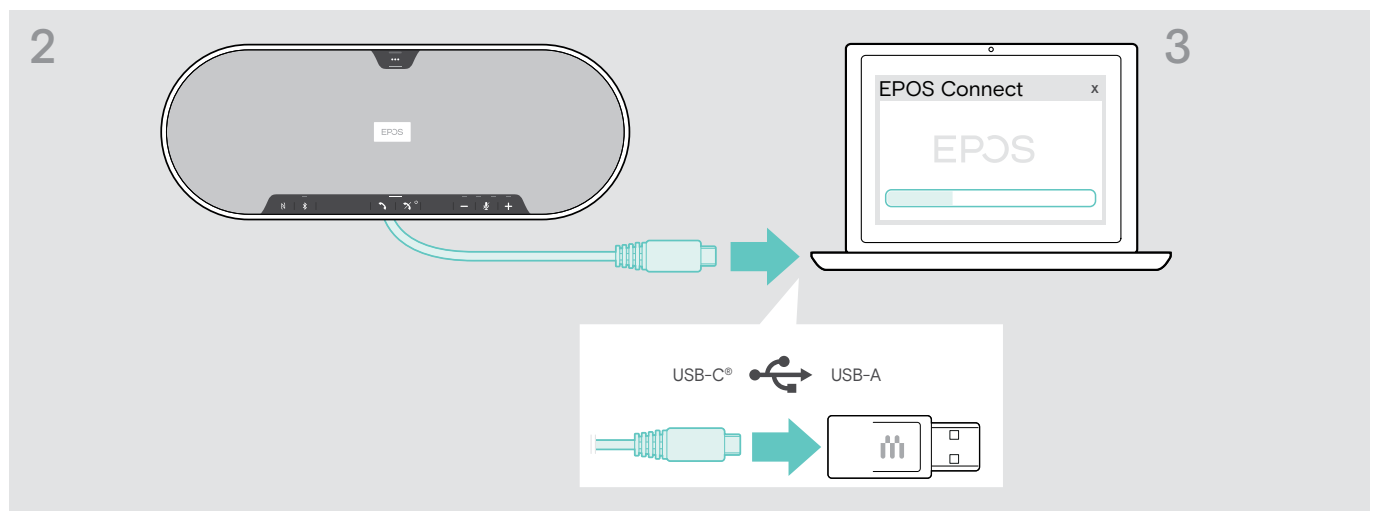

- ▷ Connect the USB connector directly to a USB-C port or to a USB-A port using the included adapter.
- ▷ Start **EPOS Connect**. **EPOS Connect** checks if the installed firmware is the latest version available on the EPOS server. If required, upgrade to the latest version.

Updating the firmware of the Bluetooth dongle BTD 800 USB

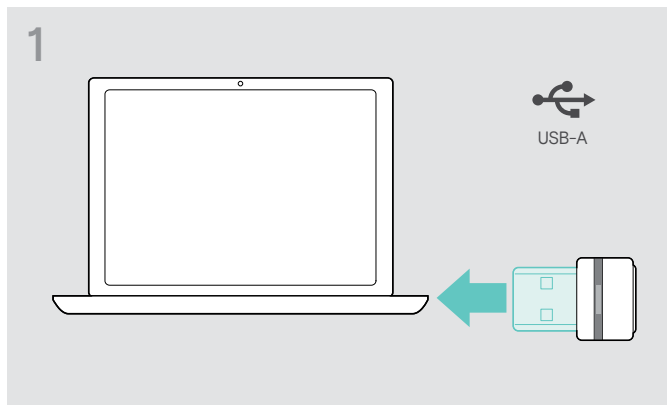

- ▶ Plug the Bluetooth USB dongle into the USB port of your computer.



- ▶ Start **EPOS Connect**. **EPOS Connect** checks if the installed firmware is the latest version available on the EPOS server. If required, upgrade to the latest version.

Updating the firmware of the expansion microphone

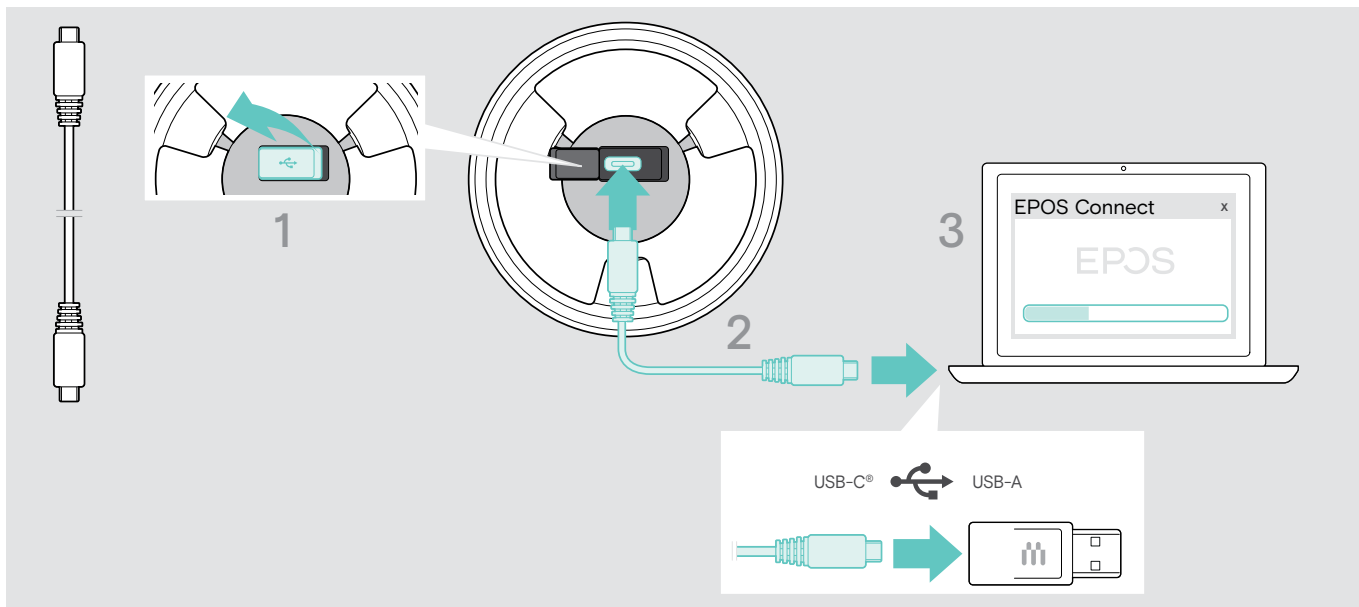

- ▶ Open the cover at the bottom.
- ▶ Connect the USB connector to the USB socket.
- ▶ Connect the USB connector directly to a USB-C port or to a USB-A port using the adapter.
- ▶ Start **EPOS Connect**. **EPOS Connect** checks if the installed firmware is the latest version available on the EPOS server. If required, upgrade to the latest version.

If a problem occurs ...

Frequently asked questions

Problem	Possible cause	Solution	Page
Speakerphone cannot be turned on	Speakerphone is not connected to the mains power supply	▷ Connect the speakerphone to the mains power supply.	11
Expansion microphone cannot be turned on	Plug not connected properly	▷ Plug in again.	17
No audio signal	USB connector not inserted correctly in the computer or adapter	▷ Plug in again.	12
	Speakerphone is not paired with the mobile device or dongle	▷ Check if the speakerphone is paired. If necessary, pair the speakerphone again.	13
	Volume is adjusted too low	▷ Increase the volume.	20
	Speakerphone is turned off	▷ Turn the speakerphone on.	18
	Computer connection: Speakerphone not selected as audio device	▷ Change the audio settings of your computer.	-
Bad audio quality	Bluetooth transmission range is exceeded	▷ Reduce the distance between speakerphone the connected Bluetooth device.	29
Speakerphone cannot be paired/connected	Pairing does not work	▷ Check if your Bluetooth device supports the Handsfree or Headset profile.	-
	Speakerphone's pairing list was cleared but it is still in the list of paired devices of the Bluetooth device	▷ Remove the speakerphone from the list of paired devices in your Bluetooth device. ▷ Pair devices again.	-
	Distance too high while pairing	▷ Reduce the distance between speakerphone the Bluetooth device.	-
	Bluetooth not enabled	▷ Make sure Bluetooth is enabled on the speakerphone and the device connecting to.	-
Activity LED is dimmed and all other LEDs off	Speakerphone in standby mode	▷ Press any button or plug in USB to end the standby mode.	27
No voice prompts announced (tones only)	Voice prompts are disabled	▷ Enable the voice prompts.	21
Speakerphone does not react to any button press	Operation of the speakerphone is faulty	▷ Press and hold the Power on/off button for 10 seconds to reboot the speakerphone.	-
		▷ Restore factory default settings.	34
No Bluetooth connection via dongle BTD 800 USB	Dongle not inserted correctly in the computer	▷ Insert the dongle again.	16
	Dongle and speakerphone not connected	▷ Pair the dongle and your speakerphone.	16
Speakerphone/dongle does not accept new devices (Pairing)	Pairing list disturbed	▷ Clear the speakerphone's list of previously paired devices.	30
		▷ Clear the dongle's list of previously paired devices.	34
Expansion microphone does not react	Expansion microphone disturbed	▷ Unplug and plug it in again.	-

If a problem occurs that is not listed in the above table or if the problem cannot be solved with the proposed solutions, please contact your local EPOS partner for assistance. To find an EPOS partner in your country, search at www.eposaudio.com

Clearing pairing list

Clearing the speakerphone's pairing list

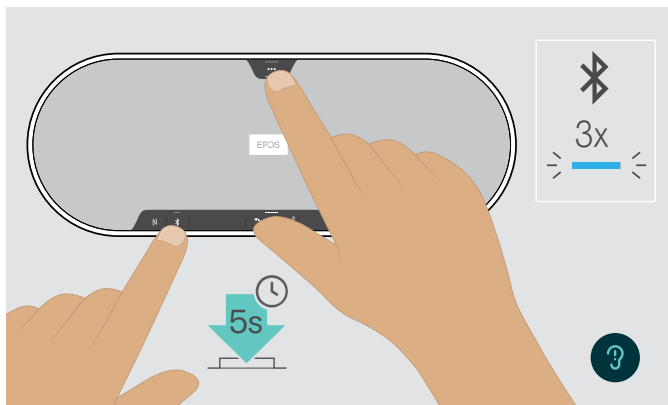

- ▶ Press and hold the multi-function button and Bluetooth button until you hear a voice prompt. The LED flashes blue three times to indicate that pairing list is cleared.

Clearing the dongle's pairing list

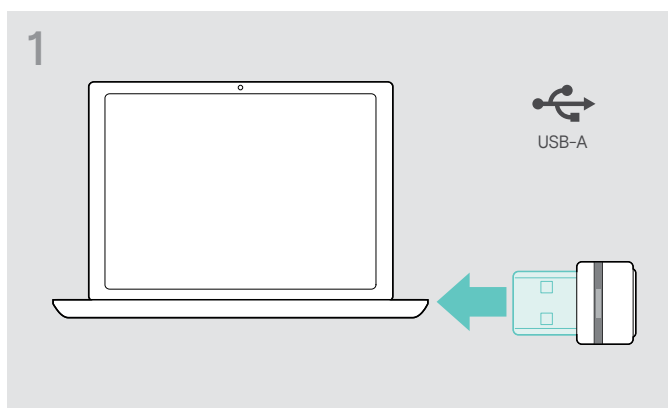

- ▶ Plug the dongle into the USB port of your computer.

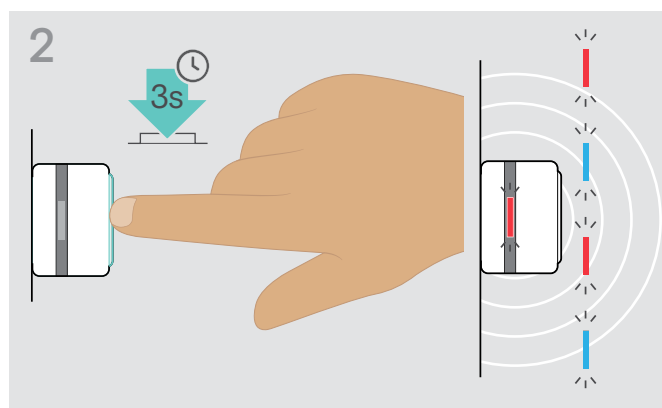

- ▶ Press and hold the button until the LED flashes blue and red.

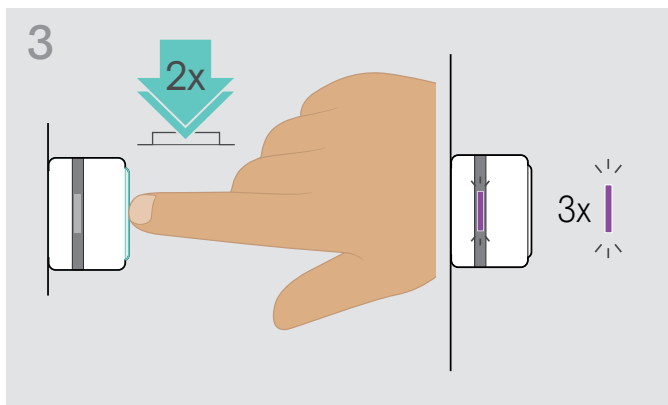

- ▶ Double tap the button. The LED flashes purple three times to indicate that pairing list is cleared. The dongle automatically enters pairing mode.

Restoring default settings

Restoring speakerphone's factory default settings

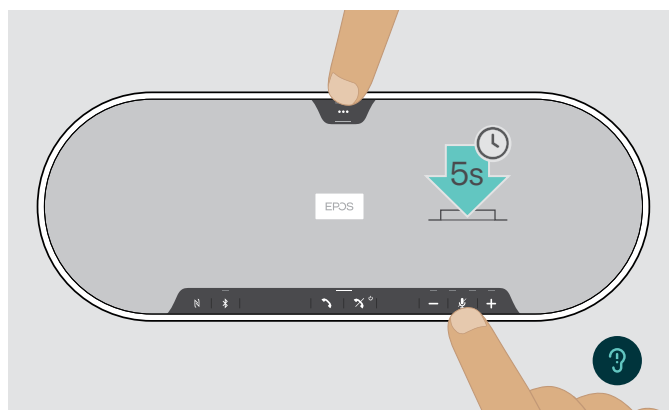

- ▶ Press and hold the mute button and multi-function button until the device restarts. All settings and the pairing list will be cleared.

If the voice prompt “Unavailable” is announced, Factory Reset is disabled in [EPOS Connect](#):

- ▶ Activate Factory Reset in EPOS Connect or contact your IT department.

Specifications

EXPAND 80 speakerphone

Dimensions (L x W x H)	315.6 x 118.6 x 46.1 mm / 12.4 x 4.7 x 1.8 in
Weight	980 g / 34.57 oz
Speaker type	Neodymium magnet
Speaker frequency response	Communication (USB / Bluetooth) 150 – 7,500 Hz Media streaming (USB / Bluetooth) 50 – 20,000 Hz
Microphone type	Beamforming digital MEMS omnidirectional microphones (6 microphones)
Microphone frequency response	150 – 7,500 Hz (USB / Bluetooth)
Microphone coverage	360 degrees
Sound Pressure	max. 85 dB
Connectors	<ul style="list-style-type: none"> • Power supply socket • USB-C socket • 2x jack socket 3.5 mm for microphones • 2x Kensington lock slot

Power supply unit

Nominal input voltage	100 – 240 V
Nominal input current	max. 0.5 A
Mains frequency	50 – 60 Hz
Nominal output voltage	5.0 V
Nominal output current	2.4 A
Weight	approx. 110 g / 3.88 oz / 0.24 lbs

BTD 800 USB Bluetooth dongle

Dimensions (W x H x D)	22 x 16 x 6 mm / 0.87 x 0.63 x 0.24 in
Weight	2 g / 0.07 oz / 0.004 lbs

Bluetooth

Bluetooth	Speakerphone: version 5.0/ class 1 Dongle: version 4.2/ class 1
Range	up to 30 m (device-dependent)
Transmission frequency	2402 – 2480 MHz
Profiles	<ul style="list-style-type: none"> • HSP Headset Profile (version 1.2) • HFP Handsfree Profile (version 1.7) • A2DP Advanced Audio Distribution Profile (version 1.3.1) • AVRCP Audio Video Remote Control Profile (version 1.6)
Output power	Speakerphone: max. 10 dBm Dongle: max. 8 dBm
Typical sensitivity	-89 dBm

EXPAND 80 Mic expansion microphone

Dimensions (Ø x H)	97 x 26.5 mm / 3.82 x 1.04 in
Weight	980 g / 2.16 lbs / 34.57 oz
Microphone type	Beamforming digital MEMS omnidirectional microphones (4 microphones)
Microphone frequency response	150 – 7,500 Hz
Microphone coverage	360 degrees
Connector	2.5 mm jack

General data

Temperature range	operation:	+10 °C to +40 °C / +50 °F to +104 °F
	storage:	-20 °C to +60 °C / -4 °F to +140 °F
Relative humidity	operation:	20% to 85%
	storage:	10% to 95%

Trademarks

The Bluetooth® word mark and logos are registered trademarks owned by Bluetooth SIG, Inc. and any use of such marks by Sennheiser Communications A/S is under license.

The N-Mark is a trademark or registered trademark of NFC Forum, Inc. in the United States and in other countries.

USB Type-C® and USB-C® are trademarks of USB Implementers Forum.

Kensington is a registered trademark of ACCO Brands. Kensington The Professionals' Choice is a trademark of ACCO Brands. All other registered and unregistered trademarks are the property of their respective owners.

EPOS

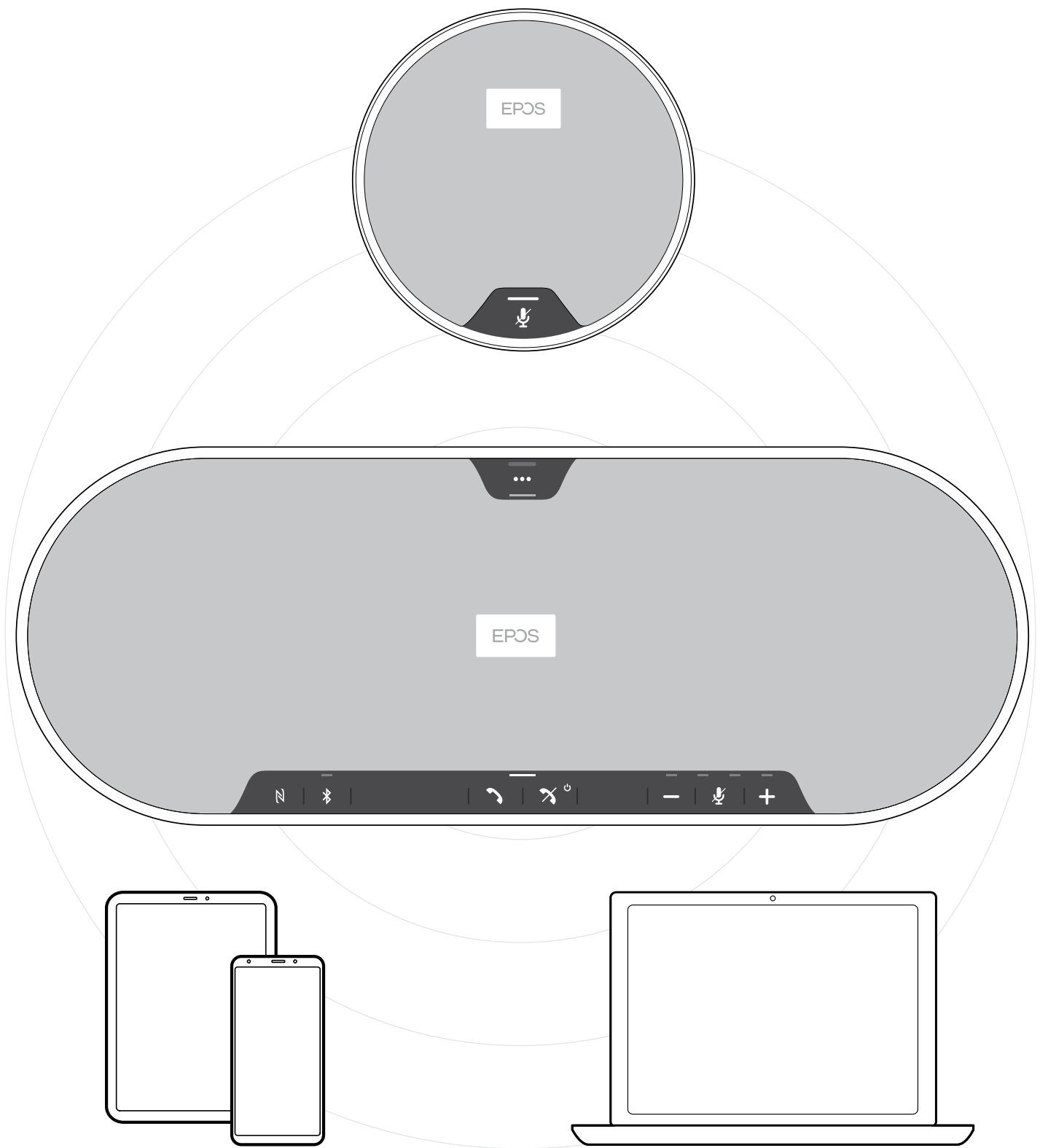

Sennheiser Communications A/S

Industriparken 27, DK-2750 Ballerup, Denmark

www.eposaudio.com